



AC/DC

PV

ISOMETER®

iso1685DP-425

isoHV1685D-425

isoLR1685DP-325

Insulation monitoring device for unearthed
AC, AC/DC and DC power supplies (IT systems)

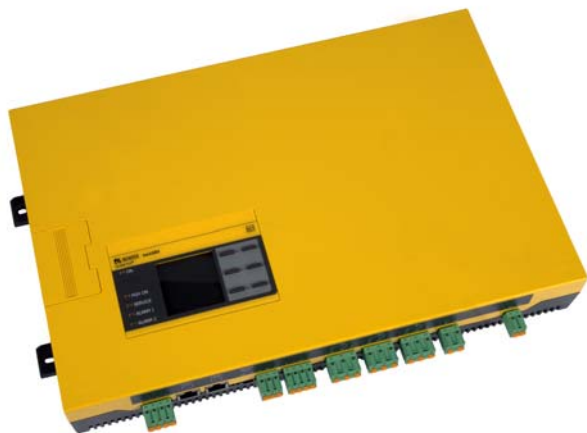

Software versions

iso1685DP-425: D0484 V3.1x, D0485 V1.2x

isoHV1685D-425: D0588 V3.1x, D0589 V2.1x

isoLR1685DP-325: D0538 V2.2x, D0539 V1.1x



Bender GmbH & Co. KG

Londorfer Str. 65 • 35305 Grünberg • Deutschland

Postbox 1161 • 35301 Grünberg • Deutschland

Tel.: +49 6401 807-0 • Fax: +49 6401 807-259

E-Mail: info@bender.de • www.bender.de

© Bender GmbH & Co. KG

All rights reserved.

Reprinting only with permission of the publisher.

Subject to change.

Fotos: Bender archive

Table of Contents

- 1. Important information7**
 - 1.1 How to use this manual..... 7
 - 1.2 Technical support..... 8
 - 1.3 Training courses..... 9
 - 1.4 Delivery conditions..... 9
 - 1.5 Storage..... 9
 - 1.6 Warranty and liability..... 9
 - 1.7 Disposal..... 10
- 2. Safety instructions11**
 - 2.1 General safety instructions..... 11
 - 2.2 Work activities on electrical installations..... 11
 - 2.3 Device-specific safety instructions..... 12
 - 2.4 Intended use..... 12
- 3. Function13**
 - 3.1 Features..... 13
 - 3.2 Product description..... 14
 - 3.3 Functional description..... 14
 - 3.4 History memory..... 16
 - 3.5 Self test..... 16
- 4. Device overview18**
 - 4.1 Dimensions..... 18
 - 4.2 Connections..... 19
 - 4.3 Display and operating elements..... 20
 - 4.4 Operating and navigating..... 22
- 5. Mounting and connection23**
 - 5.1 Mounting..... 23
 - 5.2 Connection..... 23
 - 5.3 Connection to a 3AC system with an EDS440 and and IOM441 to a 3NAC system..... 28
- 6. Commissioning29**
 - 6.1 Commissioning flow chart insulation fault monitoring..... 29
 - 6.2 Commissioning flow chart with insulation fault location..... 30
 - 6.3 Initial commissioning..... 31
 - 6.4 Recommissioning..... 34
 - 6.5 Commissioning EDS (isoxx1685DP only)..... 35

7. Display	36
7.1 Standard display	36
7.2 Fault display (active).....	37
7.3 Fault display (inactive).....	38
7.4 Acknowledging a fault message	39
7.5 Data-isoGraph	39
7.6 History memory	40
7.7 Insulation fault location	40
8. Settings	42
8.1 Device menu structure	42
8.2 Settings in the device menu	44
8.1 (1.0) Alarm settings.....	44
8.2 (1.1) Insulation alarm	44
8.2 (1.2) Profile	45
8.2 (1.3) Device.....	45
8.2 (1.4) Coupling monitoring (not for isoHR1685D-925)	45
8.2 (1.5) Power frequency $< / = 460$ Hz (for isoHR1685D-925)	46
8.2 (1.6) „Single-pole operation“ - isoHV1685D only	46
8.2 (1.6) Inputs	46
8.2 (1.7) Outputs	48
8.2 (2.0) EDS (insulation fault location only for isoxx1685DP)	50
8.2 (2.1) General.....	50
8.2 (2.2) Scanning channels.....	52
8.2 (2.3) Activating channels.....	52
8.2 (2.4) Group settings	52
8.2 (2.5) Channel	59
8.2 (2.6) Outputs	59
8.2 (2.7) Inputs	61
8.2 (2.8) Device.....	61
8.2 (2.9) Service	61
8.2 (3.0) Data measured values	61
8.2 (4.0) Control	62

- 8.2 (5.0) History 62
- 8.2 (6.0) Device settings 62
 - 8.2 (6.1) Language..... 62
 - 8.2 (6.2) Clock..... 62
 - 8.2 (6.3) Interface..... 63
 - 8.2 (6.4) Display 64
 - 8.2 (6.5) Password..... 65
 - 8.2 (6.6) Commissioning..... 65
 - 8.2 (6.7) Factory settings..... 65
 - 8.2 (6.8) Service 65
- 8.2 (7.0) Info 65
- 9. Device communication66**
 - 9.1 RS-485 interface with BMS protocol 66
 - 9.2 RS-485 interface with Modbus protocol 72
- 10. Insulation fault location (isoxx1685DP only)73**
 - 10.1 General description 73
 - 10.2 Required settings for insulation fault location 73
 - 10.3 Indication on the display 73
 - 10.4 Starting and stopping the insulation fault location 73
- 11. Alarm messages74**
- 12. Technical data75**
 - 12.1 Device profiles 75
 - 12.2 Diagrams of the leakage capacitance 79
 - 12.3 Factory settings..... 80
 - 12.4 Tabular data isoxx1685Dx-x25..... 81
 - 12.5 Standards and certifications 85
 - 12.6 Ordering details..... 85
 - 12.7 Change log 86

1. Important information

1.1 How to use this manual



This manual is intended for **qualified personnel** working in electrical engineering and electronics!



Read the manual **before** you begin to mount, connect, and commission the unit. Always keep the manual within easy reach for future reference following commissioning.

To make it easier for you to understand and revisit certain sections in this manual, we have used symbols to identify important instructions and information. The meaning of these symbols is explained below.



DANGER

This signal word indicates that there is a **high risk of danger** that will result in **electrocution** or **serious injury** if not avoided.



WARNING

This signal word indicates a **medium risk of danger** that can lead to **death** or **serious injury** if not avoided.



CAUTION

This signal word indicates a **low-level risk** that can result in minor or **moderate injury** or **damage to property** if not avoided.



This symbol denotes information intended to assist the user in making **optimum use** of the product.

1.2 Technical support

1.2.1 End customer support and advice

Technical support by phone or e-mail for all Bender products

- Questions concerning specific customer applications
- Commissioning
- Troubleshooting

Telephone: +49 6401 807-760 (365 days from 07:00 - 20:00 Uhr [MEZ/UTC +1])
Fax: +49 6401 807-259
0700BenderHelp (Tel. and Fax in Germany only)
E-mail: support@bender.de

1.2.2 Repair

Repair, calibration, update and replacement service for Bender products

- Repairing, calibrating, testing and analysing Bender products
- Hardware and software update for Bender devices
- Delivery of replacement devices
- Extended guarantee, in-house repair service, replacement devices at no extra cost

Telephone: +49 6401 807-780* (technical issues)
+49 6401 807-784*, -785* (sales)
Fax: +49 6401 807-789
E-mail: repair@bender.de

Please send the devices for **repair** to the following address:

Bender GmbH, Repair-Service,
Londorfer Strasse 65,
35305 Grünberg

1.2.3 Customer service

On-site service for all Bender products

- Commissioning, parameter setting, maintenance, troubleshooting
- Analysis of the electrical installation in the building (power quality test, EMC test, thermography)
- Training courses for customers

Telephone: +49 6401 807-752*, -762* (technical issues)/
+49 6401 807-753* (sales)
Fax: +49 6401 807-759
E-mail: fieldservice@bender.de
Internet: www.bender.de
* Mo-Thu 07:00 a.m. - 16:00 p.m., Fr 07:00 a.m. - 13:00 p.m.

1.3 Training courses

Bender is happy to provide training regarding the use of test equipment. The dates of training courses and workshops can be found on the Internet at ***www.bender.de -> Know-how -> Seminars.***

1.4 Delivery conditions

Bender sale and delivery conditions apply.

For software products, the "Softwareklausel zur Überlassung von Standard-Software als Teil von Lieferungen, Ergänzung und Änderung der Allgemeinen Lieferbedingungen für Erzeugnisse und Leistungen der Elektroindustrie" (software clause in respect of the licensing of standard software as part of deliveries, modifications and changes to general delivery conditions for products and services in the electrical industry) set out by the ZVEI (Zentralverband Elektrotechnik- und Elektronikindustrie e.V.) (German Electrical and Electronic Manufacturers' Association) also applies. Amending the "General Conditions for the supply of Products and Services of the Electrical and Electronics Industry" (GL)*

Sale and delivery conditions can be obtained from Bender in printed or electronic format.

1.5 Storage

The devices must only be stored in areas where they are protected from dust, damp, and spray and dripping water, and in which the specified storage temperatures can be ensured.

1.6 Warranty and liability

Warranty and liability claims in the event of injury to persons or damage to property are excluded if they can be attributed to one or more of the following causes:

- Improper use of the device.
- Incorrect mounting, commissioning, operation and maintenance of the device.
- Failure to observe the instructions in this operating manual regarding transport, commissioning, operation and maintenance of the device.
- Unauthorised changes to the device made by parties other than the manufacturer.
- Non-observance of technical data.
- Repairs carried out incorrectly and the use of replacement parts or accessories not approved by the manufacturer.
- Catastrophes caused by external influences and force majeure.
- Mounting and installation with device combinations not recommended by the manufacturer.

This operating manual, especially the safety instructions, must be observed by all personnel working on the device. Furthermore, the rules and regulations that apply for accident prevention at the place of use must be observed.

1.7 Disposal

Abide by the national regulations and laws governing the disposal of this device. Ask your supplier if you are not sure how to dispose of the old equipment.

The directive on waste electrical and electronic equipment (WEEE directive) and the directive on the restriction of certain hazardous substances in electrical and electronic equipment (RoHS directive) apply in the European Community. In Germany, these policies are implemented through the "Electrical and Electronic Equipment Act" (ElektroG). According to this, the following applies:

- Electrical and electronic equipment are not part of household waste.
- Batteries and accumulators are not part of household waste and must be disposed of in accordance with the regulations.
- Old electrical and electronic equipment from users other than private households which was introduced to the market after 13 August 2005 must be taken back by the manufacturer and disposed of properly.

For more information on the disposal of Bender devices, refer to our homepage at

www.bender.de -> Service & Support.

2. Safety instructions

2.1 General safety instructions

Part of the device documentation in addition to this manual is the enclosed "Safety instructions for Bender products".



Read the operating manual **before** starting to mount, connect and commission the device. After successful commissioning, keep the manual within easy reach for future reference.

2.2 Work activities on electrical installations.



Only **qualified personnel** are permitted to carry out the work necessary to install, commission and run a device or system.



Risk of electrocution due to electric shock!

Touching live parts of the system carries the risk of:

- An electric shock
- Damage to the electrical installation
- Destruction of the device

Before installing and connecting the device, make sure that the installation has been de-energised. Observe the rules for working on electrical installations.

If the device is used outside the Federal Republic of Germany, the applicable local standards and regulations must be complied with. The European standard EN 50110 can be used as a guide.

2.3 Device-specific safety instructions



Installation inside a control cabinet

If the ISOMETER® is installed inside a control cabinet, the insulation fault message must be audible and/or visible to attract attention.

IT systems with several ISOMETER®s

Make sure that only one active ISOMETER® is connected in each interconnected system. If IT systems are interconnected via coupling switches, make sure that ISOMETER®s not currently used are disconnected from the IT system and deactivated. For IT systems coupled via diodes or capacitances a central control of the different ISOMETER®s is required.

Prevent measurement errors!

When a monitored IT system contains galvanically coupled DC circuits, an insulation fault can only be detected correctly if the rectifier valves (e.g. rectifier diode, thyristors, IGBTs, frequency inverters, ...) carry a minimum current of > 10 mA.

Unspecified frequency range

When connecting to an IT system with frequency components below the specified frequency range, the response times and response values may differ from the indicated technical data. However, depending on the application and the selected measurement method, continuous insulation monitoring is also possible in this frequency range.

2.4 Intended use

The device is used for monitoring the insulation resistance in large power supply systems designed as IT systems. The specific measurement method **AMP^{PLUS}** monitors the insulation resistance also in installations where extremely high system leakage capacitances to earth exist due to interference suppression methods. Adaptation event to high leakage capacitances is automatic.

The device generates locating current pulses required for insulation fault location. That allows the localisation of the insulation fault using permanently installed or mobile insulation fault locators.

Intended use also implies:

- The observation of all information in the operating manual
- Compliance with test intervals

In order to meet the requirements of applicable standards, the equipment must be adjusted to local equipment and operating conditions by means of customised parameter settings. Please heed the limits of the range of application indicated in the technical data.

In the "Fast 2000 µF" profile, the iso1685DP can be used in photovoltaic systems.

Any other use than that described in this manual is regarded as improper.

3. Function

3.1 Features

ISOMETER® for AC IT systems with galvanically connected rectifiers or inverters and for DC IT systems. (IT = unearthed systems)

- Automatic adjustment to high system leakage capacitances, for measuring ranges see [11. "Alarm messages" on page 74](#)
- Combination of **AMP^{PLUS}** and other profile-specific measurement method
- Separately adjustable response values R_{an1} (alarm 1) and R_{an2} (alarm 2) for prewarning and alarm
- High-resolution graphic LC display for excellent readability and recording of the device status
- Connection monitoring
- Automatic device self test with automatic alarm message in the event of a fault
- Graphical representation of the insulation resistance over time (isoGraph)
- History memory with real-time clock (buffer for 13 days) for storing 1023 alarm messages with date and time
- Freely programmable digital inputs/outputs
- Remote setting of certain parameters via the Internet (COMTRAXX® gateway)
- Remote diagnosis by the Bender service via the Internet
- RS-485 interface for data exchange with other Bender devices

iso1685DP-425

- Measurement of insulation faults 200 Ω ...1 M Ω
- Integrated locating current injector up to 50 mA for insulation fault location
- Display of insulation faults selectively located by EDS systems
- Parameter setting of EDS systems
- Customer-specific texts for each measuring channel via the menu

isoLR1685DP-425

- Measurement of low-resistance insulation faults 20 Ω ...100 k Ω
- Integrated locating current injector up to 50 mA for insulation fault location
- Display of insulation faults selectively located by EDS systems
- Parameter setting of EDS systems
- Customer-specific texts for each measuring channel via the menu

isoHV1685D-425

- Measurement of insulation faults 200 Ω ...1 M Ω in IT systems with mains voltages of AC 2000 V and DC 3000 V

3.2 Product description

ISOMETER[®]s of the isoxx1685Dx-x25 device family are used for insulation monitoring of large systems designed as IT systems. The device variants described in the manual have different voltage ranges. The exact device specification can be found in [Chapter 12. Technical data](#).

The measurement method especially developed for this purpose monitors the insulation resistance even in installations where extremely high system leakage capacitances against earth exist due to interference suppression methods. Adaptation even to system-related high leakage capacitances is automatic.

The ISOMETER[®]s isoxx1685DP-x25 generate locating current pulses required for insulation fault location. That allows the localisation of the insulation fault using permanently installed or mobile insulation fault locators.

3.3 Functional description

Insulation monitoring is carried out using an active measuring pulse which is superimposed onto the IT system to earth via the integrated coupling. If the insulation resistance between the IT system and earth falls below the set prewarning response value R_{an1} , the "ALARM 1" LED lights up and relay K1 (11/12/14) switches. If the insulation resistance falls below the alarm response value R_{an2} , alarm relay K2 (21/22/24) switches and the "ALARM 2" LED lights up. When starting the insulation fault location, the "PGH ON" LED signals the locating current pulse.

3.3.1 Insulation monitoring

For insulation monitoring, a pulsating AC measuring voltage is superimposed onto the IT system. The measuring pulse consists of positive and negative rectangular impulses of the same amplitude. The period duration depends on the system leakage capacitances in each case and the insulation resistances of the system to be monitored.

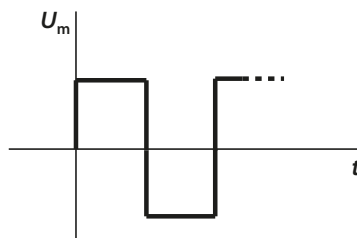

Pulse sequence of the measuring voltage for insulation fault monitoring

An insulation fault between the IT system and earth closes the measuring circuit. If the insulation resistance between system and earth falls below the set response values R_{an1} and R_{an2} (response value R_{an1} can be set equal or higher than R_{an2}), the associated alarm relays K1 (11, 12, 14) or K2 (21, 22, 24) switch. Detected insulation faults are signalled to other bus devices via the BMS bus. In addition, the alarm LEDs ALARM 1 or ALARM 2 light up.

3.3.2 Insulation fault location

For insulation fault location, a suitable locating current is superimposed onto the faulty IT system with which insulation fault locators of the EDS... series can locate insulation faults. The ISOMETER® features an internal locating current injector with I_L DC 50 mA.

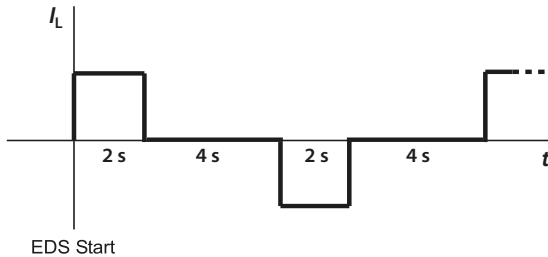

Pulse sequence of the internal locating current injector for insulation fault location



Malfunctions due to excessive locating current on sensitive system parts! The locating current flowing between the IT system and earth can cause controller faults in sensitive parts of the system, such as the PLC or relay. Ensure that the level of the locating current is compatible with the system to be monitored.

If the "Auto EDS function" is enabled, the ISOMETER® starts the insulation fault location after the value has fallen below the response values R_{an1} and R_{an2} . When starting the insulation fault location, the "PGH ON" LED signals the locating current pulse.

During the insulation fault location process, the measurement of the insulation resistance is deactivated and the coupling is disconnected from the mains. If during the insulation fault location the locating current falls below the value measurable by the EDS, the insulation fault location is terminated by the ISOMETER®.

3.3.3 Assignment of the alarm relays K1, K2, K3

K1 switches when the value falls below the alarm response value R_{an1} (insulation resistance).
K2 switches when the value falls below the alarm response value R_{an2} (insulation resistance).
K3 switches in the event of a device error or a connection fault.

3.3.4 Deactivating the device

When the device is deactivated, the coupling unit of the device is galvanically isolated from the system being monitored.

The device does not measure the insulation resistance, the message "Device inactive" appears on the display. The IT system is NOT being monitored!

The device uncouples itself from the system to be monitored through an internal system isolating switch.

Activation or deactivation is done via

- a digital input
- the menu item Alarm settings
- the BMS bus and Modbus RTU

The standby mode of the ISOMETER®, for example, enables application in coupled systems, since in interconnected systems only one insulation monitoring device may be connected.

3.3.5 Measured value transmission

All recorded measured values, operating messages and alarms are made available via the BMS bus or Modbus RTU.

3.4 History memory

All warnings, alarms and device errors are stored in the internal history memory with date and time stamp. The time the event started, the time of acknowledgement and the end of the event are recorded. The history memory can be called up and reset via the device menu (see "History" on page 62).

3.5 Self test





3.5.1 Self test after connection to the supply voltage

Once connected to the supply voltage, all internal measurement functions, the components of the process control such as data and parameter memory as well as the connections to earth are checked. The self test is completed after approx. 60 s. Afterwards, the normal measurement mode begins.

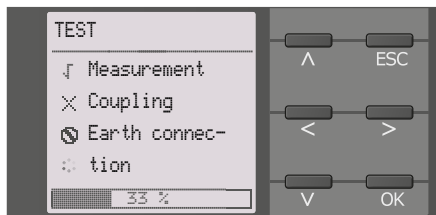
If a device error or a connection fault is detected, the corresponding alarm will be indicated in the display as well as via the alarm relay K3 (31-32-34). This relay operates continuously in NC operation, i.e. a device error is signalled even in case of a complete device failure.

During this self test, when the device is being started, the alarm relays are not switched.



	Test successful
	Test not successful
	Test not available (e.g. incorrect device settings).
	Test in progress

3.5.2 Automatic self test

All supply voltages are continuously monitored. The following tests are continuously carried out in the background:

- E-KE connection
- Temperature monitoring of coupling and locating current injector

A self test is automatically run at 24-hour intervals.

During the automatic self test, the alarm relays K1 (11-12-14) and K2 (21-22-24) are **not** switched. K3 **will not** be switched either.

3.5.3 Manual self test

The self test is started via the TEST button of the ISOMETER®.

The following tests are only carried out in the manual self test mode:

- Internal flash
- CPU register
- Watchdogs
- Oscillator
- Restart of the device including re-initialisation and recalibration
- Connection monitoring system

During the manual self test, all alarm relays are switched.

4. Device overview

4.1 Dimensions

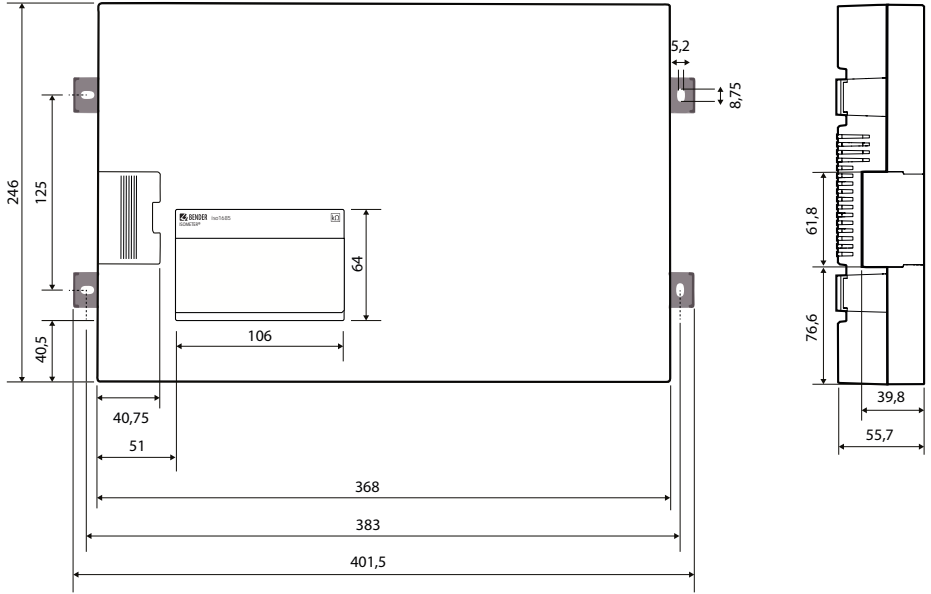

All dimensions in mm

4.2 Connections

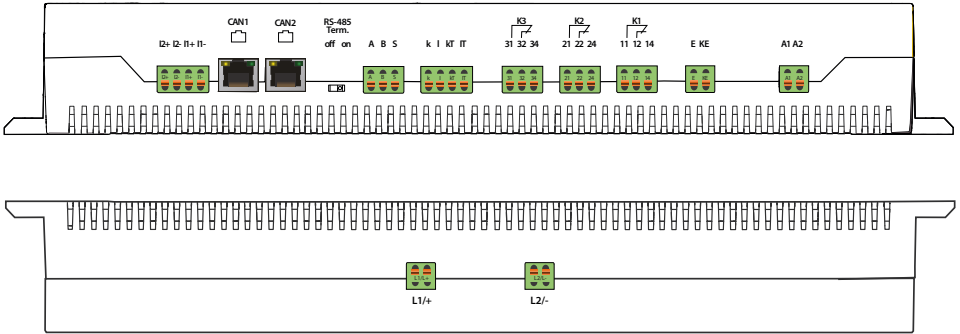

upper graphic	
I2+,I2- / I1+, I1-	digital Inputs
CAN1 / CAN2	no function
RS485 Term. off / on	RS-485 termination
A, B, S	RS-485 bus connection (A,B) Protocol: BMS S= PE potential Connect one end of shield
k, I, kT, IT	no function
31, 32, 34	Relay output for internal device errors (LED SERVICE)
21, 22, 24	Relay output for alarm 2 insulation faults
11, 12, 14	Relay output for alarm 1 insulation faults
E / KE	Separate connection of E (earth) and KE (reference) to PE. Connect both to PE
A1, A2	Supply voltage U_s DC 24 V Arbitrary polarity Connection via fuses, 2 A each
lower graphic	
L1/+	Connection to L1/+ of the IT system via 1 A fuse
L2/-	Connection to L2/- of the IT system via 1 A fuse

4.3 Display and operating elements



4.3.1 Display elements

1	ON (green)	The operation indicator lights up continuously.
2		The device display shows information regarding the device and the measurements. For further information, refer to the chapter 7. "Display" .
3	PGH ON (yellow)	The "PGH ON" LED flashes during insulation fault location. It indicates that the locating current for the insulation fault location is being generated. The "PGH ON" LED is only active for isoxx1685DP.
4	SERVICE (yellow)	When a device error is detected, the "SERVICE" LED lights up. If the LED stays lit, please check the error code list on page 71 .
5	ALARM 1 (yellow)	Insulation fault 1 (prewarning): The "ALARM 1" LED lights continuously if the insulation resistance falls below the response value 1, $R_F < R_{an1}$
		Flashes: connection fault, check earth and system (L1/+, L2/-)
6	ALARM 2 (yellow)	Insulation fault 2 (alarm): The "ALARM 2" LED lights continuously if the insulation resistance falls below the response value 2, $R_F < R_{an2}$
		Flashes: connection fault, check earth and system (L1/+, L2/-)

4.3.2 Device buttons

Adjust the device settings in the respective menu using the device buttons. Depending on the menu entry, one of the options displayed below is assigned to the buttons.

7	MENU	Opens the device menu.
	ESC	Cancels the current process or navigates one step back in the device menu.
8	EDS	Opens the EDS menu (isoxx1685DP only)
	∧	Navigates up in a list or increases a value.
9	TEST	Starts the device self test.
	>	Navigates forwards (e.g. to the next setting step) or selects a parameter.
10	RESET	Resets alarms.
	<	Navigates backwards (e.g. to the previous setting step) or selects a parameter.
11	INFO	Shows information.
	OK	Confirms an action or a selection.
12	DATA	Indicates data and values.
	∨	Navigates down in a list or reduces a value.

4.3.3 Operating elements in the service lid

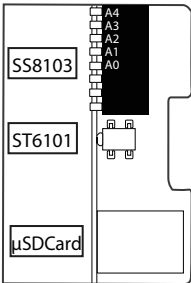

Operating elements	Function
DIP switch (SS8103)	no function
Button (ST6101)	Alarm reset
Memory card (SD card)	no function

4.4 Operating and navigating

Navigate through the device menu using the device buttons. The functions of the device buttons are described in the chapter "[Device buttons](#)" on page 21.

Navigation in lists

To make a selection in a list, navigate using the ∇ and \blacktriangle buttons to the respective menu item. Then click "OK".

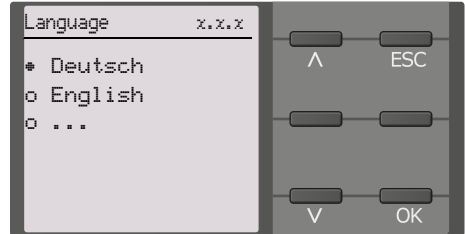

Navigation with arrows

Increase or decrease a value using the ∇ and \blacktriangle buttons. Move to the left or the right to set different values using the $<$ and $>$ buttons. The value positioned between the \blacktriangle symbols is the value that is set.

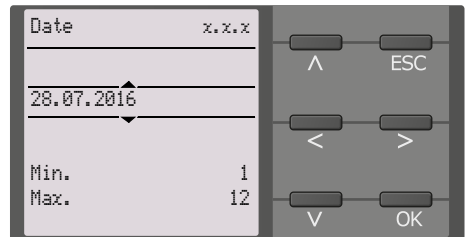

5. Mounting and connection

5.1 Mounting

Mount the device using four M5 screws, refer also to the dimension diagram where the drilling holes are illustrated (see "Dimensions" on page 18). Mount the device so that the display can be read during operation and the mains connection is (L1/+, L2/-) positioned at the top.



CAUTION

Risk of property damage due to unprofessional installation!

If more than one insulation monitoring device is connected to a conductively connected system, the system may be damaged. If several devices are connected, the device does not work and does not signal insulation faults. Make sure that only one insulation monitoring device is connected.

Heat on the enclosure surface!

The surface temperature of 60 °C can be exceeded under certain operating conditions.

Keep the cooling slots uncovered by keeping a distance of at least 15 cm above and at least 10 cm below the device to adjacent objects in order to ensure constant air circulation.

Risk of injury from sharp-edged terminals!

Risk of lacerations. Touch the enclosure and the terminals with due care.

5.2 Connection

5.2.1 Connection requirements



Only **qualified personnel** are permitted to carry out the work necessary to install, commission and run a device or system.



DANGER

Risk of electrocution due to electric shock!

Touching live parts of the system carries the risk of:

- An electric shock
- Damage to the electrical installation
- Destruction of the device

Before installing and connecting the device, make sure that the installation has been de-energised. Observe the rules for working on electrical installations.



Ensure disconnection from the IT system!

When insulation or voltage tests are to be carried out, the device must be isolated from the system for the test period. Otherwise the device may be damaged.

Check proper connection!

Prior to commissioning of the installation, check that the device has been properly connected and check the device functions. Perform a functional test using an earth fault via a suitable resistance.

Pluggable push-wire terminals

All terminals are pluggable push-wire terminals. Solid connecting wires can be directly plugged in. For connection of flexible cables, the push-wire terminals must be pushed open by pressing the corresponding orange interlocking mechanism with a flat-head screwdriver.

5.2.2 Step-by-step connection of the ISOMETER®

Connect the device according to the wiring diagram.

Proceed as follows:

1. Connect terminals E and KE to earth (PE)
2. Connect terminals A and B to the BMS bus
3. Connect terminal S to the bus conductor shield (only at one end of the conductor)
4. Connect terminal L1/+ to L1 of the system to be monitored
5. Connect terminal L2/- to L2 of the system to be monitored



The coupling terminals L1/+ and L2/- are locked. To unplug the terminals, the orange sliders must be slid towards the front (towards the device) to unlock the terminal. Now the terminal can be unplugged.

6. Connect terminal A1/A2 to the supply voltage U_s
7. Connect alarm outputs 11/12/14, 21/22/24 and 31/32/34.

5.2.3 Connecting the EDS to the ISOMETER® isoxx1685DP



CAUTION

Risk of malfunctions due to excessive locating current on sensitive system parts!

The locating current flowing between the IT system and earth can cause controller faults in sensitive parts of the system, such as the PLC or relay. Ensure that the level of the locating current is compatible with the system to be monitored

Risk of incorrect measurement

The supplied locating current may influence other connected insulation fault location systems. If they measure the injected locating current, the measurement might be incorrect..



Insulation monitoring is deactivated while the insulation fault location is active.

Wiring diagram

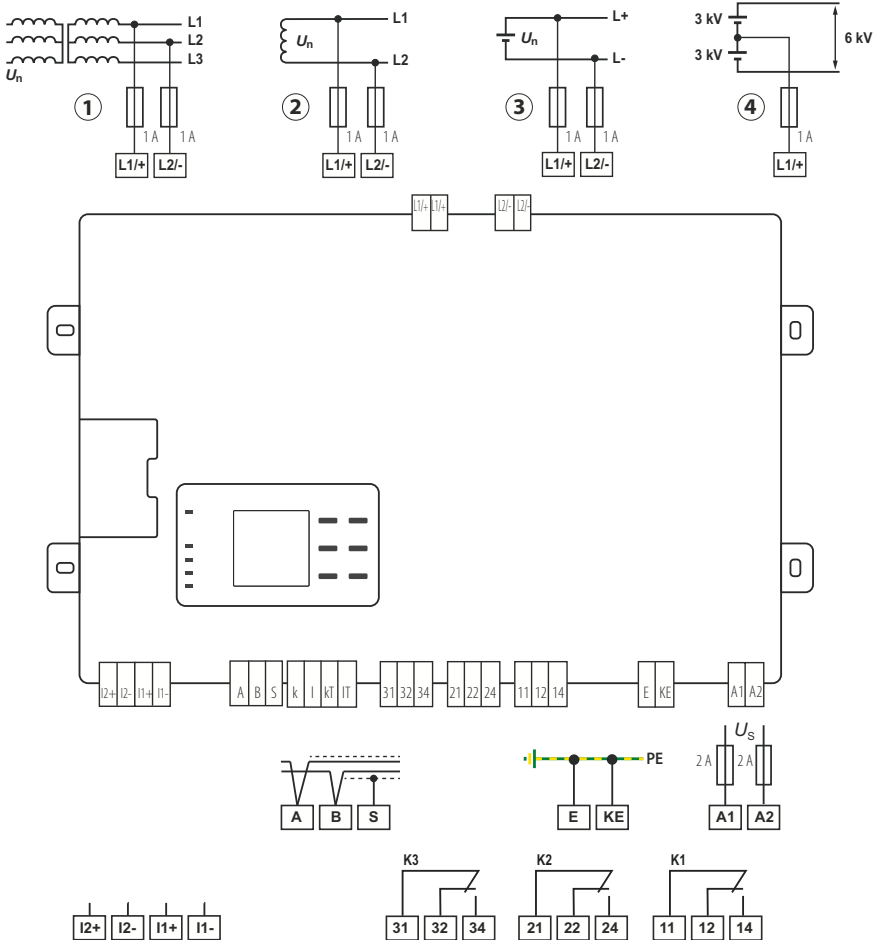

1	Connection isoxx1685xx to 3AC
2	Connection isoxx1685xx to AC
3	Connection isoxx1685xx to DC
4	Connection isoHV1685xx to DC with center tap
	Lower device connections see 4.2 "Connections" on page 19

**WARNING*****Injury, fire and damage to property due to a short circuit in isoHV1685D-425 and isoHR1685D-925***

According to DIN VDE 0100-430, protective devices (fuses) used to protect against short circuits when terminals L1/+ and L2/- are coupled to the IT system to be monitored can be omitted if the wiring is designed in such a manner that the risk of a short circuit is kept to a minimum. Ensure short-circuit-proof and earth-fault-proof wiring.

**CAUTION*****Make sure that the operating voltage is correct!***

Prior to insulation and voltage tests, the ISOMETER® must be disconnected from the IT system for the duration of the test. In order to check the correct connection of the device, a functional test has to be carried out before starting the system.



In case of single-pole coupling (see connection diagram 4), the function of the coupling monitoring must be deactivated and the function of the single-pole operation must be activated! The functions are described in the chapters 8.2 (1.4) "[Coupling monitoring \(not for isoHR1685D-925\)](#)" on page 45 and 8.2 (1.6) "[„Single-pole operation“ - isoHV1685D only](#)" on page 46.

5.3 Connection to a 3AC system with an EDS440 and and IOM441 to a 3NAC system

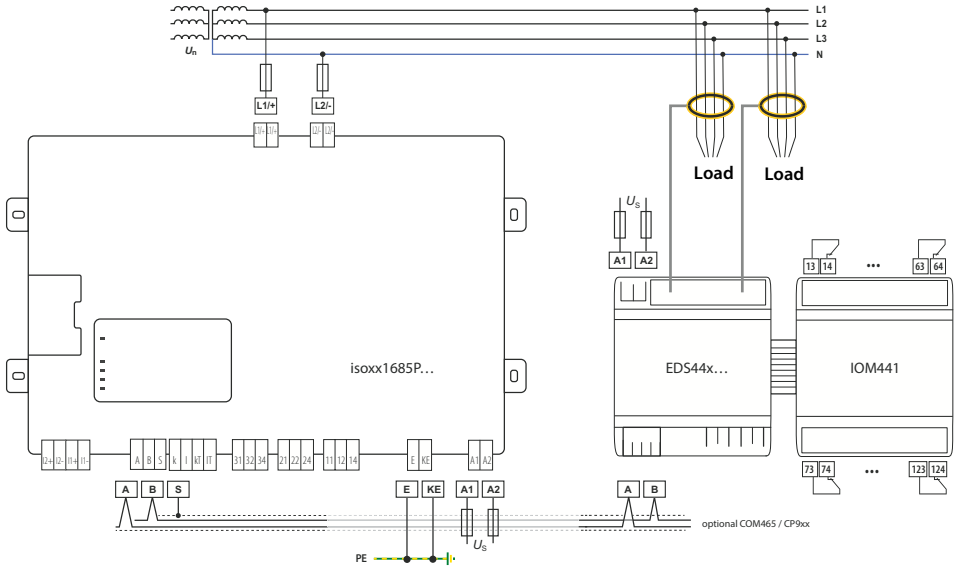

6. Commissioning

6.1 Commissioning flow chart insulation fault monitoring

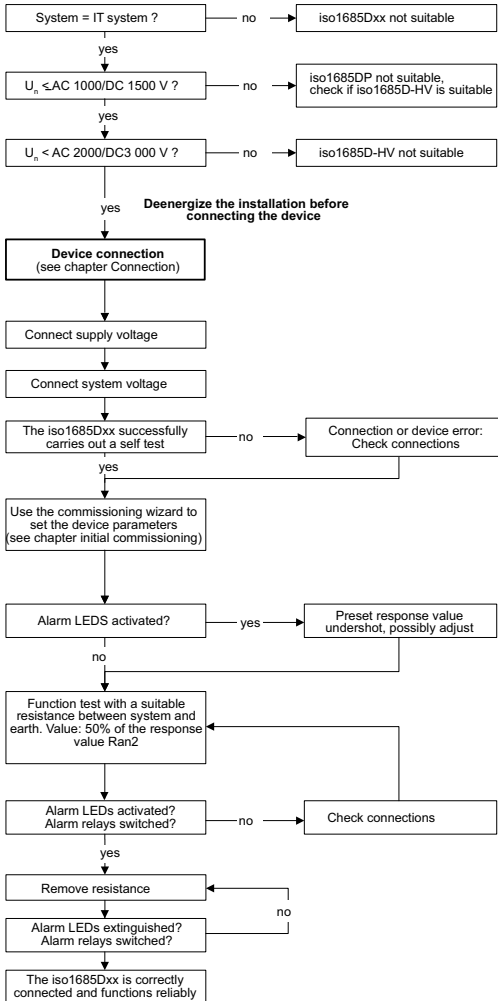

6.2 Commissioning flow chart with insulation fault location

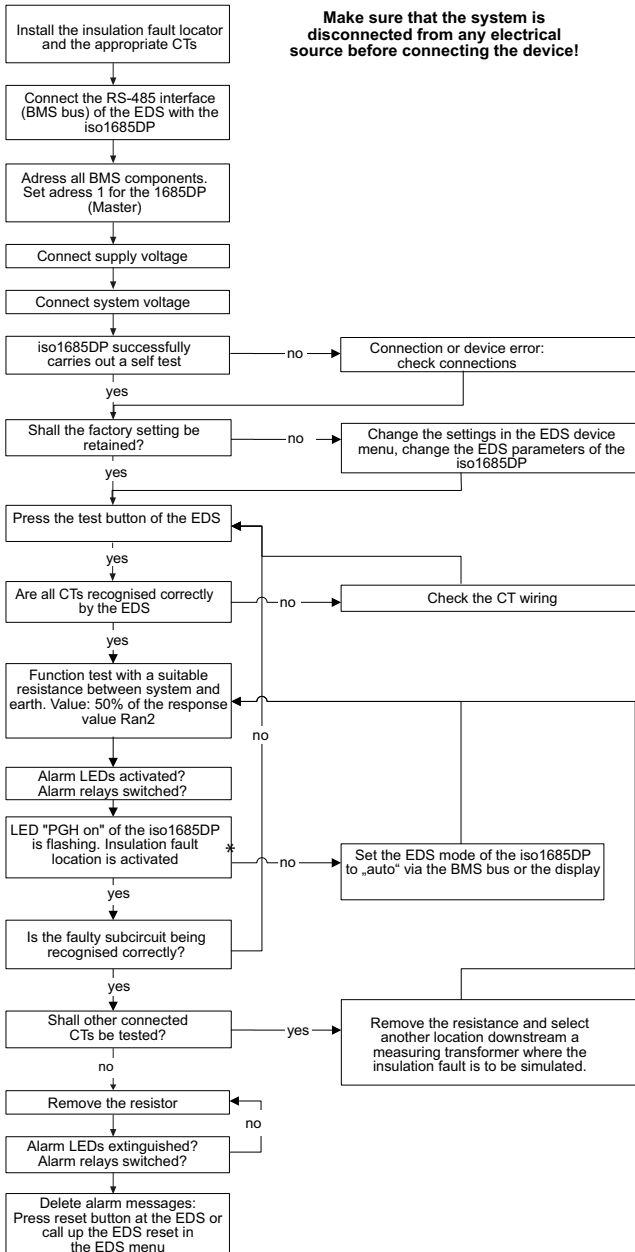

6.3 Initial commissioning

Follow the instructions of the commissioning wizard on the display.

Use the device buttons to navigate. For a description of the device buttons, refer to "[Device buttons](#)" on page 21.

6.3.1 Setting the language

The language selected here will be used in the menu and for device messages.

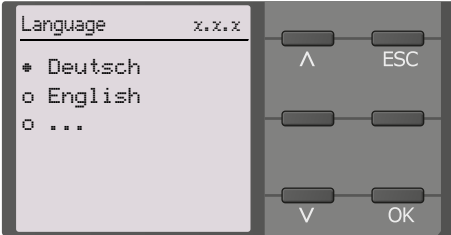

6.3.2 Setting date and time

Alarm messages in the history memory and the insulation resistance value over time can only be assigned correctly to the isoGraph when date and time are set correctly.

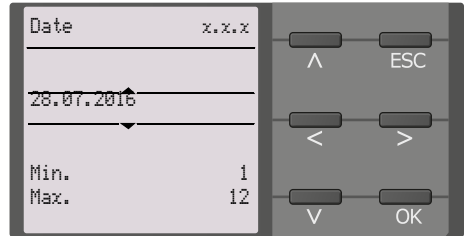
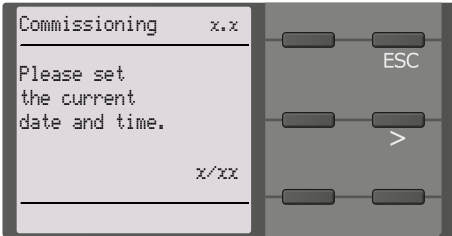

6.3.3 Setting the profile

In order to optimally adapt the insulation monitoring device to the system to be monitored, select a profile that suits your system. For an overview of the profiles, refer to "[Device profiles](#)" on page 75. The Power circuits profile is suitable for most of the IT systems.

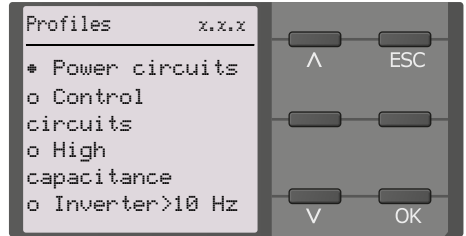
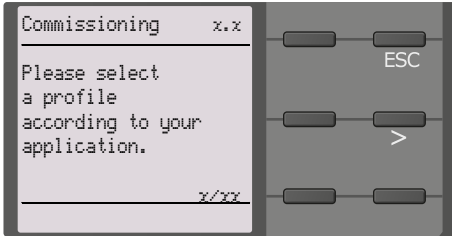

The response value range changes depending on the selected profile. See "[Device profiles](#)" on page 75.

6.3.4 Setting response value R_{an1} for alarm 1

Set the prewarning response value here.¹

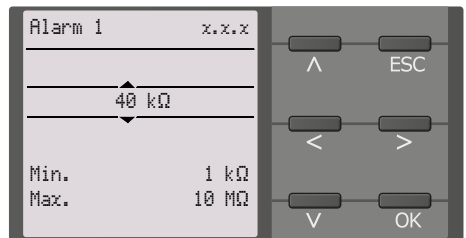
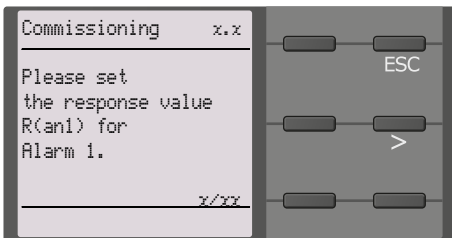

1. The response values shown in the screenshots represent the default settings of an iso1685DP device. The values differ depending on the device variant.

6.3.5 Setting response value R_{an2} for alarm 2

Set the response value for the main alarm here.

A value of 50 Ω/V is recommended for the main alarm.

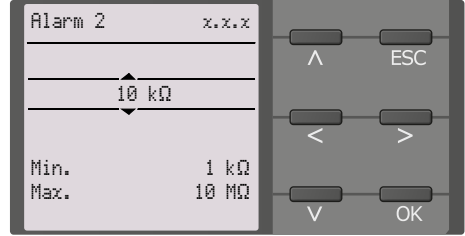
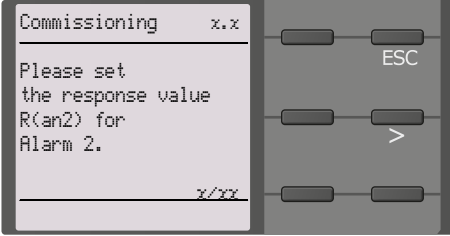

6.3.6 Setting the EDS mode (isoxx1685DP only)

Set the mode for the insulation fault location to manual, automatic or 1 cycle. For further information, refer to "Mode" on page 50.

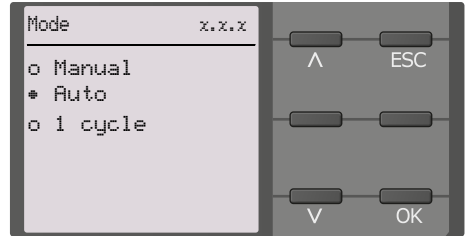
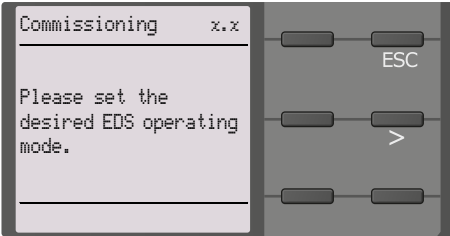

6.3.7 Setting the EDS current (isoxx1685DP only)

Set the maximum locating current.

EDS441: 1-5 mA

EDS440: 10-50 mA

For further information, refer to "Current" on page 51.

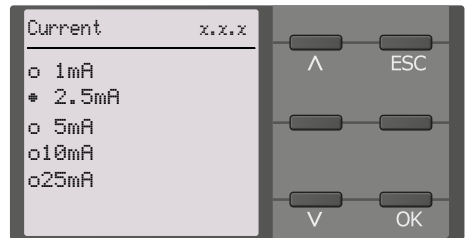
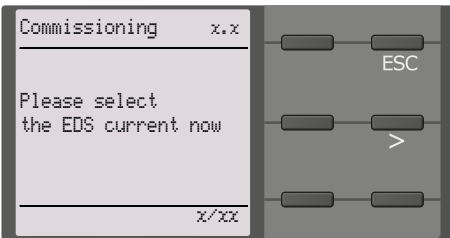

6.3.8 TEST

Start the device test.

During the test, all relays switch and the ALARM 1 and ALARM 2 LEDs light up briefly.

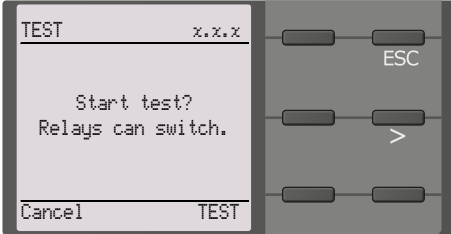

6.4 Recommissioning

If the device has already been put into operation before, the self test will be started shortly after the supply voltage has been connected. Restart the commissioning wizard using the following menu path:

Menu/Device settings/Commissioning

This menu can be used to modify previously made settings.



Observe device status!

Once initial commissioning has been completed and the initial measurement taken, the device changes from the alarm state to normal state by adhering to the set response values.

If the device has been commissioned before, the self test is not performed again. It can be called up via the "Control" menu ([refer to page 62](#)).

6.5 Commissioning EDS (isoxx1685DP only)

Proceed as follows to put into operation an EDS after commissioning the ISOMETER®:

1. Set the mode for the insulation fault location to manual, automatic or 1 cycle. For a description of the different modes, refer to ["Mode" on page 50](#).

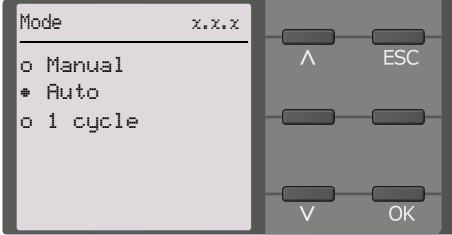

2. Test if the maximum locating current matches the EDS and adjust if necessary (refer to [6.3.7 "Setting the EDS current \(isoxx1685DP only\)" on page 33](#)).

Menu path: Menu/EDS/General/Current

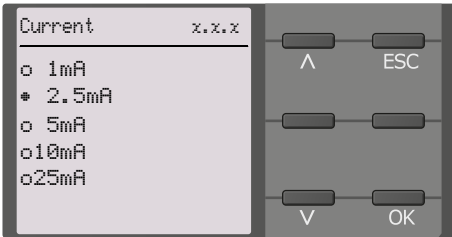

In addition to this chapter, the commissioning of the ISOMETER® in combination with an EDS is described in the chapter [6.2 "Commissioning flow chart with insulation fault location" on page 30](#).

7. Display

7.1 Standard display

During normal operation, the ISOMETER® displays the message "OK" and below, the currently measured insulation resistance.



The signal quality of the measurement suits the selected profile.
The better the signal quality, the faster and more exact the device can measure.



The signal quality of the measurement does not suit the selected profile. Select a different measurement profile.



Update period between the measuring pulses.

In the bottom line of the display, the set response values for "R(an)" are indicated. In the example below, $R_{an1}=40\text{ k}\Omega$ und $R_{an2}=10\text{ k}\Omega$.



7.2 Fault display (active)

An active fault is displayed by .

The upper part of the display turns orange and displays the fault message.

Depending on the type of fault, the LEDs "ALARM 1", "ALARM 2" or "SERVICE" are activated.

In the following example, a resistance has been detected. Since the values $R_{an1}=40\text{ k}\Omega$ and $R_{an2}=10\text{ k}\Omega$ are both below the set response value, „ALARM 1“ and „ALARM 2“ have been triggered.

If several fault messages have appeared, you can navigate through the faults using the ∇ and \blacktriangle buttons.

If the value falls below R_{an1} in a DC system or a DC offset is detected in an AC system, additional detailed information regarding the DC offset will be displayed.

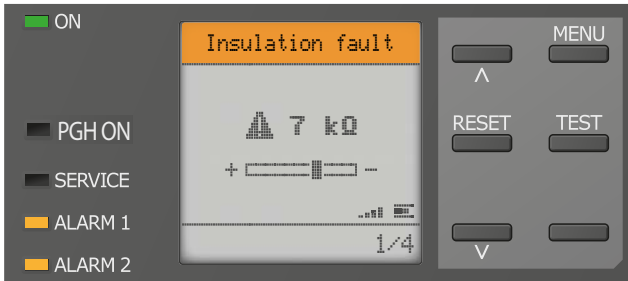

7.3 Fault display (inactive)

An inactive fault is indicated by . If several faults have occurred, the number of faults will also be indicated.

The message shown on the display below means that there has been a fault in the past but the device is no longer in fault condition.

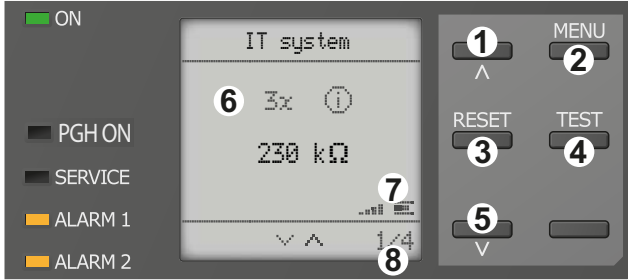

Keypad

- 1 Next fault message
- 2 MENU selection
- 3 Acknowledge fault
- 4 Perform test measurement
- 5 Previous fault message

Display

- 6 Number of faults that have occurred
- 7 Signal quality & measuring pulses
- 8 Number of the selected fault/
Fault message count

If several fault messages have appeared, you can navigate through the faults using the ∇ and \wedge buttons. In addition to the type of fault and the associated alarm value, you can see when the fault has occurred and for how long it has been active.

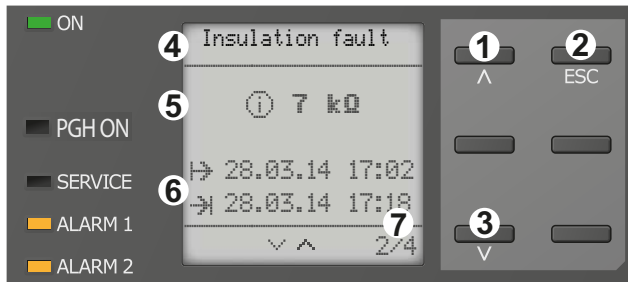

Keypad

- 1 Next fault message
- 2 Exit view
- 3 Previous fault message

Display

- 4 Fault description
- 5 Alarm value
- 6 Fault appeared/
Fault disappeared
- 7 Number of the selected fault/
Fault message count

7.4 Acknowledging a fault message

In order to acknowledge the fault message and return to the ISOMETER®'s standard display, all faults must be acknowledged by means of the "RESET" button.

This means that fault messages can only be reset when the cause of the fault has been eliminated.

Press the "RESET" button, then \triangleright and "OK" to clear the fault memory. The ISOMETER® returns to the standard display.



Keypad

- 1 Press „RESET“-button
- 2 Select RESET by pressing \triangleright
- 3 Press the "OK" button to confirm the deletion

Display

- 4 Functions

7.5 Data-isoGraph

The isoGraph represents the chronological sequence of the insulation resistance over time. This graphical representation can be displayed over the following time periods: hour, day, week, month and year.

The measured values for individual representations are stored in a separate memory. Up to 100 measured values are available to represent each graph. and the resolution of each graph is determined by these values.

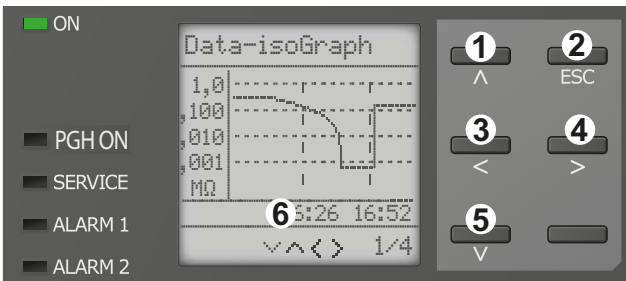

Keypad

- 1 Change measured value (jump forward one value)
- 2 Exit view
- 3 Change scaling (zoom in)
- 4 Change scaling (zoom out)
- 5 Change measured value (jump back one value)

Display

- 6 Present time scaling

7.6 History memory

Up to 1023 alarm messages and device errors are stored in the history memory with date and time stamp. If the history memory is deleted, the minimum insulation resistance R_{\min} will also be reset in the Data-isoGraph at **Menu -> Data Measured values -> Reset Data-isoGraph**.

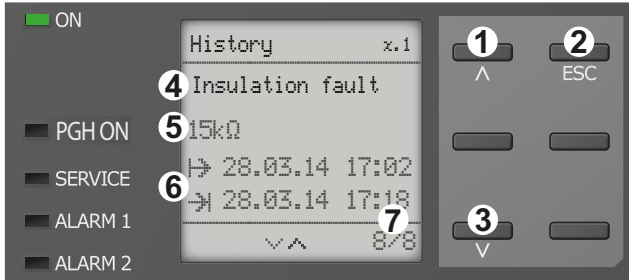

Keypad





- 1 Next message
- 2 Exit view
- 3 Previous message

Display

- 4 Fault description
- 5 Alarm value
- 6 Fault appeared/
Fault disappeared
- 7 Number of the selected fault/
Fault message count

7.7 Insulation fault location

When EDS mode is activated, the ISOMETER® indicates the message "Ins. fault locat.". Below, on the left side it indicates which EDS mode is activated. On the right side, it indicates the polarity change of the measuring pulses including the pause in between. The different pulse phases are indicated by the corresponding symbols. *

	Positive measuring pulse *
	Pause
	Negative measuring pulse *
	The insulation fault location has been started manually and runs continuously. No insulation measurement takes place.
43 s	Insulation fault location in auto mode and 1 cycle. Time countdown of a measurement cycle.
---	Time cannot be displayed



* Display for low-frequency measurements

In the LAB procedure, the pulse can last up to one minute. Therefore, there is no constant "changing" of the display symbols. The respective symbols are displayed continuously for the pulse time of up to 1 minute.

Insulation fault location in auto mode and 1 cycle.

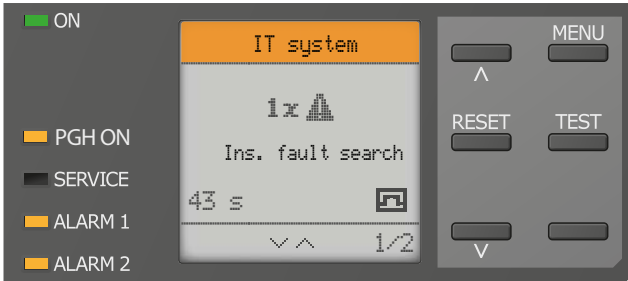

Insulation fault location has been started manually.

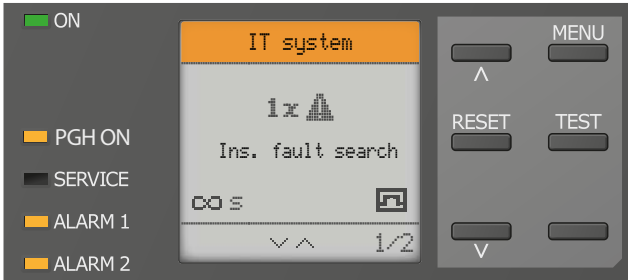

For further information regarding the different modes, refer to ["Mode" on page 50](#).

8. Settings

8.1 Device menu structure

1. Alarm settings	<ul style="list-style-type: none"> 1. Insulation alarm <ul style="list-style-type: none"> 1. Alarm 1 2. Alarm 2 3. Memory 4. Start alarm 2. Profile 3. Device 4. Coupling monitor 5. System frequency 6. Single pole operation 6. Inputs <ul style="list-style-type: none"> -> isoHV1685DP-425 only 1. Digital 1 <ul style="list-style-type: none"> 1. Mode 2. t(on) 3. t(off) 4. Function 2. Digital 2 <ul style="list-style-type: none"> 1. Mode 2. t(on) 3. t(off) 4. Function 7. Outputs <ul style="list-style-type: none"> 1. Relay 1 <ul style="list-style-type: none"> 1. TEST 2. Relay mode 2. Relay 2 <ul style="list-style-type: none"> 1. TEST 2. Relay mode 3. Buzzer <ul style="list-style-type: none"> 1. TEST 2. Function 1 3. Function 2 4. Function 3 8. Outputs (isoHV1685...)
2. EDS (see 8.1.1)	<ul style="list-style-type: none"> -> see footnote 1) only for following devices: <ul style="list-style-type: none"> - iso1685DP - isoLR1685DP
3. Data meas. Values	
4. Control	<ul style="list-style-type: none"> 1. TEST 2. RESET 3. EDS
5. History	<ul style="list-style-type: none"> 1. History 2. Delete
6. Device settings	<ul style="list-style-type: none"> 1. Language 2. Clock <ul style="list-style-type: none"> 1. Time 2. Format 3. Summer time 4. Date 5. Format 3. Interface <ul style="list-style-type: none"> 1. Mode: 2. BMS <ul style="list-style-type: none"> 1. Address 3. Modbus/RTU <ul style="list-style-type: none"> 1. Address 2. Baudrate 3. Parity 4. Stoppbits 4. Display <ul style="list-style-type: none"> 1. Brightness 5. Password <ul style="list-style-type: none"> 1. Password 2. Status 6. Commissioning 7. Factory setting 8. Service

1) The numbering of the menu items differs for the models isoHV1685D-425 and isoHR1685D-925 from menu item 3 (Data meas. values).

8.1.1 Menu item EDS (isoxx1685DP only)

2. EDS only for following devices: - iso1685DP - isoLR1685DP	1. General	1. Mode 2. Current
	2. Scan for channels	
	3. Enable channel	
	4. Group settings	1. Channel (select 1 ... x) <ol style="list-style-type: none"> CT CT Monitor IΔL Response value IΔn Response value
		2. Outputs <ol style="list-style-type: none"> Common relay <ol style="list-style-type: none"> TEST Relay mode Function 1 Function 2 Function 3 Channel relay ... see 1. Buzzer <ol style="list-style-type: none"> TEST Function 1 Function 2 Function 3 Digital Output ... see 3.
		3. Digital Input <ol style="list-style-type: none"> Mode t(on) t(off) Function
		4. Device settings <ol style="list-style-type: none"> System type Frequency Trigger Fault memory
	5. Channel	1. Channel (select 1 ... x) <ol style="list-style-type: none"> Name CT monitor IΔL Response value IΔn Response value
	6. Outputs	1. Common relay <ol style="list-style-type: none"> TEST Relay mode Function 1 Function 2 Function 3
		2. Channel relay ... see 1. 3. Buzzer <ol style="list-style-type: none"> TEST Function 1 Function 2 Function 3
	4. Digital Output ... see 3.	
7. Inputs	1. Input (select 1 ... x) <ol style="list-style-type: none"> Mode t(on) t(off) Function 	
8. Device	1. Device (select 1 ... x) <ol style="list-style-type: none"> Name Trigger Memory 	
9. Service		

The settings of the ISOMETER® are explained in section 8.2 in the order of the device menu.

8.2 Settings in the device menu

8.2 (1) Alarm settings

The limit values for the insulation resistances of alarm 1 and alarm 2 can be specified in the alarm settings menu and the profile of the ISOMETER® can be adjusted. If the password query has been enabled in the device menu (refer to "Password" on page 65), enter the device password in order to change the settings.

The following functions can be adjusted:

8.2 (1.1) Insulation alarm

In the Insulation alarm menu, the ISOMETER® limit values for alarm 1 and alarm 2 can be set. Activation or deactivation of the two alarm levels R_{an1} for alarm 1 and R_{an2} for alarm 2 are illustrated in the following graphic:

An alarm will become inactive as soon as the hysteresis of the set operating value is exceeded.

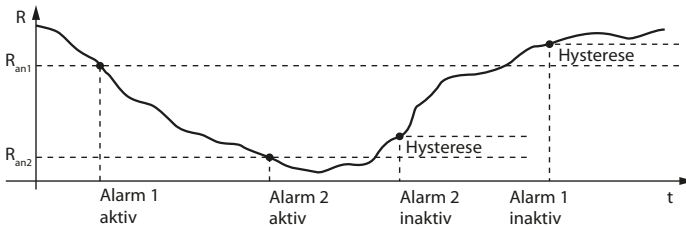

8.2 (1.1.1) Alarm 1

An insulation resistance of 200 Ω...1 MΩ can be set for alarm 1.
Condition: alarm 1 ≥ alarm 2.

8.2 (1.1.2) Alarm 2

An insulation resistance of 200 Ω...1 MΩ can be set for alarm 2.



Response value ranges

The response value range depends on the device variant. For further information on the response value ranges of individual variants, refer to [chapter 12. "Technical data" from page 75.](#)

8.2 (1.1.3) Fault memory

Automatic reset of inactive faults at the outputs
(relays 11-12-13, 21-22-24):

- *on If a fault becomes inactive, the programmed outputs remain in fault condition until they are reset manually.
- *off If a fault becomes inactive, the programmed outputs automatically change their state.

8.2 (1.1.4) Start Alarm (for isoHR1685D-925)

- *Start Alarm ON Device start with alarm message and a measured value of 0 k Ω
- *Start Alarm OFF Device start without alarm message and a measured value of ∞ k Ω

8.2 (1.2) Profile

Adapt the area of application of the ISOMETER[®] to your system profile. For a description of the profiles, refer to "[Device profiles](#)" on page 75.

The following can be selected:

- *Power circuits Suitable for most IT systems.
- *High capacitance Suitable for systems with high leakage capacitances.
Limit of the measuring range: 200 k Ω
- *Inverter >10 Hz¹⁾ Suitable for systems with dynamic frequency control by inverters in the range of 10...460 Hz.
- *Inverter <10 Hz Suitable for systems with extremely low frequency control in the range of 1...460 Hz.
- *Fast 2000 μ F¹⁾ Suitable for systems with very high leakage capacitances, e.g. in large-scale photovoltaic systems. Limit of the measuring range: 50 k Ω

1) not for isoHR1685D-925

8.2 (1.3) Device

Set the ISOMETER[®] insulation resistance measurement function to active or inactive:

- *Active The device is active.
- *Inactive The device DOES NOT measure the insulation resistance and is disconnected from the system to be monitored (system disconnection, not for isoHR1685D-925). The IT system is NOT being monitored!
The message `Device inactive` appears on the display.
The ALARM 1 and ALARM 2 LEDs light up.

8.2 (1.4) Coupling monitoring (not for isoHR1685D-925)

The ISOMETER[®] continuously monitors the coupling of energised systems. The coupling of de-energised systems is monitored at 24-hour intervals. This monitoring function can be activated or deactivated.

- *on Coupling monitoring is activated.
- *off Coupling monitoring is deactivated.



Coupling monitoring in single-pole operation

Coupling monitoring must be deactivated in single-pole operation. (see 8.2 (1.6) "„Single-pole operation" - isoHV1685D only" on page 46

8.2 (1.5) Power frequency ≤ 460 Hz (for isoHR1685D-925)

- * ≤ 460 Hz The power frequency is set to max. 460 Hz.
- * > 460 Hz The power frequency is set to over 460 Hz.

8.2 (1.6) „Single-pole operation“ - isoHV1685D only

The isoHV1685D-425 can be used in applications up to DC 6 kV. The prerequisite for this is the center tap / the center tapping, to which the device is connected single-pole. (5.2 "Connection" on page 23 Connection screen 4)

- * ein Die Funktion wird aktiviert.
- * aus Die Funktion wird deaktiviert.

8.2 (1.6) Inputs

The ISOMETER® provides 2 digital inputs (I1, I2) that are freely configurable.

8.2 (1.6.1) Digital 1

The following parameters can be set for the digital input:

8.2 (1.6.1.1) Mode

The operating mode for the digital input can be set to the following values:

Active high

An event is carried out on the falling edge of the digital input (low to high). Response time $t(\text{on})/t(\text{off})$ after a switch-on signal.

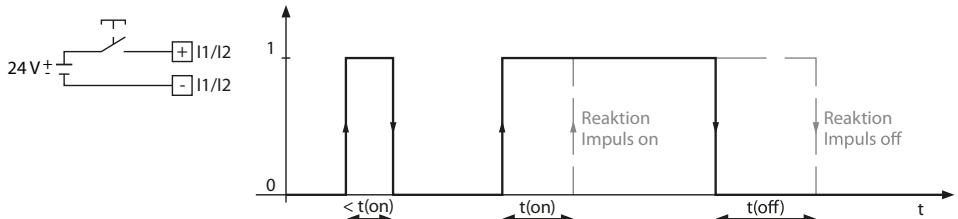

Active low

An event is carried out on the falling edge of the digital input (high to low). Response time $t(\text{on})/t(\text{off})$ after a switch-off signal.

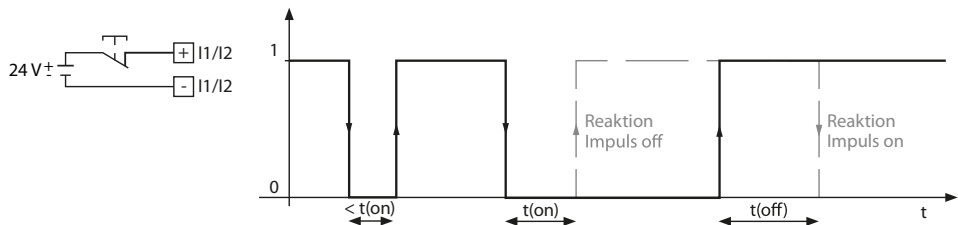

8.2 (1.6.1.2) t(on)

The response time t(on) after a switch-on signal can be set between 100 milliseconds and 5 minutes.

8.2 (1.6.1.3) t(off)

The response time t(off) after a switch-off signal can be set between 100 milliseconds and 5 minutes.

8.2 (1.6.1.4) Function

The parameters for the function of the digital inputs of the ISOMETER® can be set differently:

*off	Digital input without function
*TEST	Device self test
*RESET	Reset of fault and alarm messages
*Deactivating the device	The device DOES NOT measure the insulation resistance, the message <code>Device inactive</code> appears on the display. The IT system is NOT being monitored! The device disconnects itself from the system to be monitored through an internal system isolating switch.
*Start initial measurement	Starting a new measurement. All recorded measurements are discarded
*Insulation fault location (isox1685DP only)	The insulation fault location is started. For this purpose, the digital input must be active.

8.2 (1.6.2) Digital 2

See [chapter 8.2 \(1.6.1\) "Digital 1"](#).

8.2 (1.7) Outputs

The ISOMETER® provides a total of 3 alarm relays.
The following parameters can be set for relay 1 and relay 2:

8.2 (1.7.1) Relay 1

The following parameters can be set for the relay:

8.2 (1.7.1.1) TEST

The functional test of the relay can be activated or deactivated. This only applies to the manual test and not to the cyclic device self test:

- *on The manual test checks the switching function of the relay
- *off The manual test does not check the switching function of the relay

8.2 (1.7.1.2) Relay mode

The relay mode can be adapted to the application:

- *N/C Normally closed - N/C operation contacts 11-12-14/21-22-24 (The alarm relay is energised during normal operation).
- *N/O Normally open - N/O operation contacts 11-12-14/21-22-24 (The alarm relay is de-energised during normal operation).

8.2 (1.7.2) Relay 2

See [chapter 8.2 \(1.7.1\) "Relay 1"](#).

8.2 (1.7.3) Relay 3:



Relay 3 does not appear in the device menu. The operating mode is set to N/C operation and the parameters cannot be adjusted.

8.2 (1.7.4) Buzzer

The following parameters can be set for the buzzer:

8.2 (1.7.4.1) TEST

The functional test of the buzzer can be activated or deactivated. This only applies to the manual test and not to the cyclic device self test:

- *on The manual test activates the buzzer sound.
- *off The manual test does not activate the buzzer sound.

8.2 (1.7.4.2) Function 1

The following parameters can be set:

*off	The function is not used.
*Ins. alarm 1	The status of the output changes when the value falls below the set response value R_{an1} .
*Ins. alarm 2	The status of the output changes when the value falls below the set response value R_{an2} .
*Connection fault	The status of the output changes when one of the following connection faults occurs: <ul style="list-style-type: none">• No low-resistance connection between the line conductors.• No low-resistance connection of terminals E and KE to earth (PE).
*Device error	The status of the output changes in the event of an internal device error.
*Common alarm	The status of the output changes on the occurrence of any alarm and fault messages (Ins. alarm 1 & 2, DC-/DC+ alarm, symmetrical alarm, connection faults and device errors).
*Device inactive	The status of the output changes when the device has been deactivated via a digital input or the control menu.

8.2 (1.7.4.3) Function 2

See [chapter 8.2 \(1.7.4.2\) "Function 1"](#).

8.2 (1.7.4.4) Function 3

See [chapter 8.2 \(1.7.4.2\) "Function 1"](#).

8.2 (2) EDS (insulation fault location only for isoxx1685DP)



For insulation fault location, the protocol of the RS-485 interface must be set to BMS (menu 8.2 (6.3) "Interface"). Insulation fault location via the Modbus RTU protocol is not possible.

8.2 (2.1) General

8.2 (2.1.1) Mode

To locate insulation faults, select one of the following three available modes for insulation fault location.

- *Manual In manual mode, the insulation fault location starts immediately. If the insulation fault location is started, it remains active without considering the insulation resistance and the alarm message of the ISOMETER®.
- *auto In auto mode, the insulation fault location starts automatically as soon as the response value of alarm 2 of the ISOMETER® falls below the preset value. The insulation fault location is cyclically interrupted for an insulation measurement. If the insulation fault still exists after the interruption, the insulation fault location starts again. The insulation fault location only stops when alarm 2 is inactive. If a new insulation fault appears, the insulation fault location restarts automatically.
- *1 cycle In 1-cycle mode, the insulation fault location starts automatically as soon as the response value of alarm 2 of the ISOMETER® falls below the preset value. The insulation fault location is stopped after one cycle. If the insulation fault still exists after the interruption, the insulation fault location does NOT start again. If a new insulation fault appears, the insulation fault location restarts automatically for one cycle.

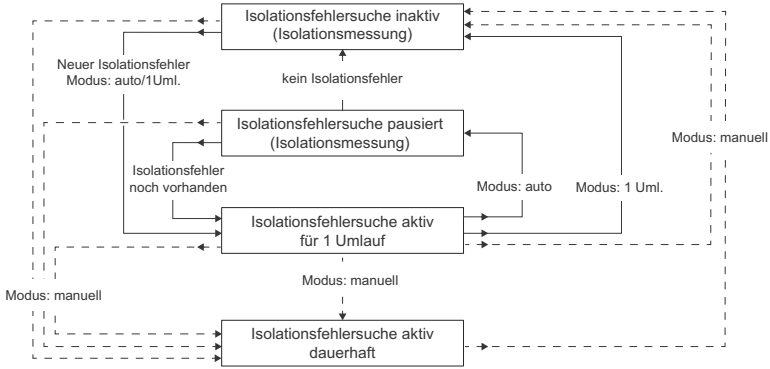

Insulation fault location diagram



Do not carry out a manual test during a manually started insulation fault location, since the insulation fault location would be aborted by it.

8.2 (2.1.2) Current



Risk of malfunctions due to excessive locating current on sensitive system parts! The locating current flowing between the IT system and earth can cause controller faults in sensitive parts of the system, such as the PLC or relay. Ensure that the level of the locating current is compatible with the system to be monitored.

Set the maximum locating current on the ISOMETER®. The device-specific maximum locating currents can be found in the table below.

• 1mA	for EDS441-x
• 2.5mA	for EDS441-x
• 5mA	for EDS44x-x
• 10mA	for EDS440-x
• 25mA	for EDS440-x
• 50mA	for EDS440-x

8.2 (2.2) Scanning channels

For a successful insulation fault location, all active measuring channels must be determined. Indicate if you would like to start the search for EDS measuring channels.

- *Cancel Aborts the scan process.
- *Start Starts the scan process (search) for EDS channels.

Also refer to ["Commissioning EDS \(isox1685DP only\)" on page 35](#).



If one bus device fails, the ISOMETER® asks whether it should search for measuring channels and then automatically determines all channels again. Also refer to ["Alarm messages" from page 74](#).

8.2 (2.3) Activating channels

During initial commissioning all channels are inactive. Before configuring the channels, they must be activated in this menu. Navigate to the required selection point using the \wedge and \vee buttons. Confirm selection by pressing "OK". Select the measuring channels to be activated with the \triangleright button.. Multiple selection is possible here.

- *Select all All channels are selected.
- *No selection No channel is selected.
- *Invert selection The current selection is inverted.
- *Channel 1 (BS 2/1) A single channel is selected.
- ...
- *Channel 12 (BS 2/12)

8.2 (2.4) Group settings

Use group settings to adjust the settings for several EDS or EDS channels simultaneously or to read out settings.

If you would like to make settings for each EDS or each EDS channel individually, please refer to the menus from [chapter 8.2 \(2.5\) "Channel"](#) to [chapter 8.2 \(2.8\) "Device"](#).



The values indicated in the group settings are not the values of the individual EDS but the factory settings or the last adjusted values in the ISOMETER®. To see the values of the individual EDS devices, please navigate to the menus from [chapter 8.2 \(2.5\) "Channel"](#) to [chapter 8.2 \(2.8\) "Device"](#).

8.2 (2.4.1) Channel

Before configuring a measuring channel, it must be activated. Select which measuring channel should be activated and configure.

- *Select all All channels are selected.
- *No selection No channel is selected.
- *Invert selection The current selection is inverted.
- *Channel 1 (BS 2/1) A single channel is selected.
- *Channel 2 (BS 2/2)
- *Channel 3 (BS 2/3)

Navigate to the required selection point using the \wedge and \vee buttons. Confirm selection by pressing "OK". Activate the selected measuring channel using the \triangleright button and navigate to its setting options.

8.2 (2.4.1.1) Current transformers

Set the used current transformer (CT).

- *Type A W.../WR.../WS.../
W/WS8000
- *Type AB W...AB (type AB depends on the variant)

8.2 (2.4.1.2) CT monitoring

Enable or disable the CT monitoring.

If CT monitoring is enabled, an alarm is signalled as soon as a fault occurs on a current transformer of an activated channel (short circuit or interruption).

- *on CT monitoring is enabled
(the current transformers are monitored).
- *off CT monitoring is disabled (the current transformers are not monitored).

8.2 (2.4.1.3) Response value $I_{\Delta L}$

Set the response value for $I_{\Delta L}$ (main alarm for insulation fault location) between 200 μ A and 10 mA. The response value must be below the set locating current (refer to 6.3.7 "Setting the EDS current (isox1685DP only)" on page 33).



The permissible response value and the response sensitivity depend on the connected EDS (EDS440x or EDS441x).

8.2 (2.4.1.4) Response value $I_{\Delta n}$

Set the response value for $I_{\Delta n}$ (alarm for residual current measurement) between 100 mA and 10 A.



The permissible response value and the response sensitivity depend on the connected EDS (EDS440x or EDS441x).

8.2 (2.4.2) Outputs

In this menu, the settings for the outputs of the EDS can be made.

- *Common relays
- *Channel relay
- *Buzzer
- *Digital output

8.2 (2.4.2.1) Common relay

Select the relays to be configured.

- *Select all All relays are selected.
- *No selection No relay is selected.
- *Invert selection The current selection is inverted.
- *Relay 1 (BS 2/1) A single relay is selected.
- *Relay 2 (BS 2/2)

8.2 (2.4.2.1.1) TEST

The functional test of the relays can be activated or deactivated. This only applies to the manual test and not to the cyclic device self test.

- *on The manual test checks the switching function of the relays.
- *off The manual test does not check the switching function of the relays.

8.2 (2.4.2.1.2) Relay mode

The relay operating mode can be adapted to the application.

- *N/C Normally closed - N/C operation contacts 13-14/23-24 (in fault-free condition, the alarm relay is energised).
- *N/O Normally open - N/O operation contacts 13-14/23-24 (in fault-free condition, the alarm relay is de-energised).

8.2 (2.4.2.1.3) Function 1

Up to three functions can be assigned to one output. The functions are linked to an OR operator:

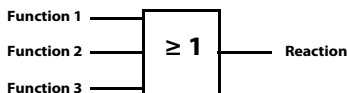

Set the function for the outputs:

*off	The function is not used.
*I _{ΔL}	The status of the output changes if an insulation fault is detected (EDS function) on one of the measuring channels.
*I _{ΔN}	The status of the output changes if the residual current (RCM function) is exceeded.
*Device error	The status of the output changes in the event of an internal device error.
*Connection fault	The status of the output changes if one of the following measuring current transformer connection faults occurs: <ul style="list-style-type: none"> • Measuring current transformer defective • Power supply cable interrupted • Power supply cable short-circuited
*Common alarm	The status of the output changes on the occurrence of any alarms and fault messages (I _{ΔL} alarm, I _{ΔN} alarm, connection and device error).

8.2 (2.4.2.1.4) Function 2

See [chapter 8.2 \(2.4.2.1.3\) "Function 1"](#).

8.2 (2.4.2.1.5) Function 3

See [chapter 8.2 \(2.4.2.1.3\) "Function 1"](#).

8.2 (2.4.2.2) Channel relay

Select the relay you want to set.

```
*Relay 1 (BS 2/1)
...
```

Submenus see [chapter 8.2 \(2.4.2.1\) "Common relay"](#) (2.4.2.1.1) to (2.4.2.1.5)

8.2 (2.4.2.3) Buzzer

Select the buzzers to be configured.

*Select all	All buzzers are selected.
*No selection	No buzzer is selected.
*Invert selection	The current selection is inverted.
*Buzzer 1 (BS 2/1)	A single buzzer is selected.

Afterwards, assign the selected buzzers to the events on which they should trip.

8.2 (2.4.2.3.1) TEST

See [chapter 8.2 \(2.4.2.1.1\) "TEST"](#).

8.2 (2.4.2.3.2) Function 1

Set the function for the buzzer:

*off	The function is not used.
*I _{ΔL}	The buzzer signals if an insulation fault is detected (EDS function) on one of the measuring channels.
*I _{ΔN}	The buzzer signals if the residual current (RCM function) is exceeded.
*Device error	The buzzer signals in the event of an internal device error.
*Connection fault	The buzzer signals if one of the following measuring current transformer connection faults occurs: <ul style="list-style-type: none">• Measuring current transformer defective• Power supply cable interrupted• Power supply cable short-circuited
*Insulation fault location active	The buzzer signals active insulation fault location
*Common alarm	The buzzer signals on the occurrence of any alarms and fault messages (I _{ΔL} alarm, I _{ΔN} alarm, connection and device error).

8.2 (2.4.2.3.3) Function 2

See [chapter 8.2 \(2.4.2.3.2\) "Function 1"](#).

8.2 (2.4.2.3.4) Function 3

See [chapter 8.2 \(2.4.2.3.2\) "Function 1"](#).

8.2 (2.4.2.4) Digital output

Select the digital outputs of the EDS to be configured.

*Select all	All digital outputs are selected.
*No selection	No digital output is selected.
*Invert selection	The current selection is inverted.
*Dig. output 1 (BS 2/1)	A single digital output is selected.

Afterwards, make the settings for the selected digital inputs of the EDS.

8.2 (2.4.2.4.1) TEST

The functional test of the digital output can be activated or deactivated. This only applies to manual tests and not to the cyclic device self test:

*on	The manual test changes the state of the digital output.
*off	The manual test does not change the state of the digital output.

8.2 (2.4.2.5) Function 1

See [chapter 8.2 \(2.4.2.1.3\) "Function 1"](#).

8.2 (2.4.2.6) Function 2

See [chapter 8.2 \(2.4.2.1.3\) "Function 1"](#).

8.2 (2.4.2.7) Function 3

See [chapter 8.2 \(2.4.2.1.3\) "Function 1"](#).

8.2 (2.4.3) Dig. input

Select the digital inputs of the EDS to be configured:

*Select all	All digital inputs are selected.
*No selection	No digital input is selected.
*Invert selection	The current selection is inverted.
*Dig. input 1 (BS 2/1)	A single digital input is selected.
*Dig. input 2 (BS 2/2)	

Afterwards, make the settings for the selected digital inputs of the EDS.

8.2 (2.4.3.1) Mode

The operating mode for the digital input can be set to the values below. For a description, refer to "[Setting the EDS mode \(isox1685DP only\)](#)" on page 33. The following can be selected:

*Active high	An event is carried out on the falling edge of the digital input (low to high).
*Active low	An event is carried out on the falling edge of the digital input (high to low).

8.2 (2.4.3.2) t(on)

The response time t(on) after a switch-on signal can be set between 100 milliseconds and 5 minutes. For a description, refer to "[Setting the EDS mode \(isox1685DP only\)](#)" on page 33.

8.2 (2.4.3.3) t(off)

The response time t(off) after a switch-off signal can be set between 100 milliseconds and 5 minutes. For a description, refer to "[Setting the EDS mode \(isox1685DP only\)](#)" on page 33.

8.2 (2.4.3.4) Function

*off	Digital input without function
*TEST	Device self test
*RESET	Reset of fault and alarm messages

8.2 (2.4.4) Device settings

*Select all	All devices are selected.
*No selection	No device is selected.
*Invert selection	The current selection is inverted.
*BMS bus 2 (1-12)	

8.2 (2.4.4.1) System type

Adjust the EDS to the IT system to be monitored.

*DC	DC system
*AC	Single-phase AC system
*3AC	3AC system

8.2 (2.4.4.2) Frequency

Configure the power frequency of the IT system to be monitored.

- *50 Hz
- *60 Hz
- *400 Hz
- *DC



Settings made to the menu points ,System type' and ,Frequency' will only have an effect on connected EDS460 and NOT on EDS44... devices.

8.2 (2.4.4.3) Trigger

The locating current pulse of the ISOMETER® is synchronised with the measurement technology in the EDS via the BMS bus. This allows a more reliable detection of the locating current pulse in the event of disturbances. Disturbances can be caused e.g. by variable-speed drives, rectifiers, actuators, noise filters, PLCs, or control electronics.

- *Com Synchronisation via BMS bus. The EDS only searches for insulation faults if the insulation fault location has been started. Less time is needed for the insulation fault location than with the "auto" setting.
- *auto No synchronisation
(e.g. if there is no BMS bus).
The EDS continuously searches for insulation faults.



If the trigger mode is set to "auto", the use of a portable EDS must be enabled in the menu (menu item = "on"), since the measurement method is correspondingly adjusted via this menu item.

8.2 (2.4.4.4) Fault memory

Faults that only occur temporarily can be stored.

- *on After eliminating the cause of fault, alarm messages remain stored until a reset is carried out. This function applies to alarm and device fault messages.
- *off The EDS exits the alarm state as soon as the cause of fault is eliminated.

8.2 (2.5) Channel

In this menu, each channel can be configured. See also [chapter 8.2 \(2.4.1\) "Channel"](#).

8.2 (2.5.1) Name

Enter a name for the selected channel. This name will also be displayed on the gateways and in the web server and can be edited via these as well.

8.2 (2.5.2) CT monitoring

See [chapter 8.2 \(2.4.1.2\) "CT monitoring"](#).

8.2 (2.5.3) Response value $I_{\Delta L}$

See [chapter 8.2 \(2.4.1.3\) "Response value \$I_{\Delta L}\$ "](#).

8.2 (2.5.4) Response value $I_{\Delta n}$

See [chapter 8.2 \(2.4.1.4\) "Response value \$I_{\Delta n}\$ "](#).

8.2 (2.6) Outputs

In this menu, each output can be configured. See also [chapter 8.2 \(2.4.2\) "Outputs"](#).

8.2 (2.6.1) Common relay

Select the relays to be configured.

- *Select all All relays are selected.
- *No selection No relay is selected.
- *Invert selection The current selection is inverted.
- *Relay 1 (BS 2/1) A single relay is selected.
- *Relay 2 (BS 2/2)

8.2 (2.6.1.1) TEST

See [chapter 8.2 \(2.4.2.1.1\) "TEST"](#).

8.2 (2.6.1.2) Relay mode

See [chapter 8.2 \(2.4.2.1.2\) "Relay mode"](#).

8.2 (2.6.1.3) Function 1

See [chapter 8.2 \(2.4.2.1.3\) "Function 1"](#).

8.2 (2.6.1.4) Function 2

See [chapter 8.2 \(2.4.2.1.3\) "Function 1"](#).

8.2 (2.6.1.5) Function 3

See [chapter 8.2 \(2.4.2.1.3\) "Function 1"](#).

8.2 (2.6.2) Channel relay

Select the relay to be configured.

- *Relay 1 (BS 2/1)
- ...

8.2 (2.6.2.1) TEST

See [chapter 8.2 \(2.4.2.1.1\) "TEST"](#).

8.2 (2.6.2.2) Relay mode

See [chapter 8.2 \(2.4.2.1.2\) "Relay mode"](#).

8.2 (2.6.2.3) Function 1

See [chapter 8.2 \(2.4.2.1.3\) "Function 1"](#).

8.2 (2.6.2.4) Function 2

See [chapter 8.2 \(2.4.2.1.3\) "Function 1"](#).

8.2 (2.6.2.5) Function 3

See [chapter 8.2 \(2.4.2.1.3\) "Function 1"](#).

8.2 (2.6.3) Buzzer

In this menu, each buzzer can be configured. See also [chapter 8.2 \(2.4.2.3\) "Buzzer"](#).

8.2 (2.6.3.1) TEST

See [chapter 8.2 \(2.4.2.1.1\) "TEST"](#).

8.2 (2.6.3.2) Function 1

See [chapter 8.2 \(2.4.2.1.3\) "Function 1"](#).

8.2 (2.6.3.3) Function 2

See [chapter 8.2 \(2.4.2.1.3\) "Function 1"](#).

8.2 (2.6.3.4) Function 3

See [chapter 8.2 \(2.4.2.1.3\) "Function 1"](#).

8.2 (2.6.4) Digital output

In this menu, each digital output can be configured. See also [chapter 8.2 \(2.4.2.4\) "Digital output"](#).

8.2 (2.6.4.1) TEST

See [chapter 8.2 \(2.4.2.4.1\) "TEST"](#).

8.2 (2.6.4.2) Function 1

See [chapter 8.2 \(2.4.2.1.3\) "Function 1"](#).

8.2 (2.6.4.3) Function 2

See [chapter 8.2 \(2.4.2.1.3\) "Function 1"](#).

8.2 (2.6.4.4) Function 3

See [chapter 8.2 \(2.4.2.1.3\) "Function 1"](#).

8.2 (2.7) Inputs

In this menu, each digital input can be configured. For this purpose, select a digital input.

- *Dig. input 1 (BS 2/1)
- *Dig. input 2 (BS 2/2)

8.2 (2.7.1) Mode

See [chapter 8.2 \(2.4.3.1\) "Mode"](#).

8.2 (2.7.2) t(on)

See [chapter 8.2 \(2.4.3.2\) "t\(on\)"](#).

8.2 (2.7.3) t(off)

See [chapter 8.2 \(2.4.3.3\) "t\(off\)"](#).

8.2 (2.7.4) Function

See [chapter 8.2 \(2.4.3.4\) "Function"](#).

8.2 (2.8) Device

8.2 (2.8.1) Name

8.2 (2.8.2) Trigger

See [chapter 8.2 \(2.4.4.3\) "Trigger"](#).

8.2 (2.8.3) Fault memory

See [chapter 8.2 \(2.4.4.4\) "Fault memory"](#).

8.2 (2.9) Service

The service menu can only be accessed by Bender service staff.

8.2 (3) Data measured values

The ISOMETER® stores certain measured values for a specific period of time. These data can be viewed at the "Data meas. values" menu item. Navigate through the different views using the \wedge and \vee buttons:

*Data - isoGraph	Displays the insulation resistance and chronological sequence.
*Data - Insulation	Displays the current insulation resistance and the system leakage capacitance.
*Data - Voltage	Displays the system voltages and the partial voltages to earth
*Data - PGH (isoxx1685DP only)	Displays measuring current, locating current, performance and insulation fault location mode.
*Data - Temperature	Mains connection and locating current injector

8.2 (4) Control

In the control menu, a manual test can be performed and the alarm messages can be reset:

- | | |
|--------|-----------------------------------|
| *TEST | Manual device test |
| *RESET | Reset of fault and alarm messages |
| *EDS | Start insulation fault location |

8.2 (5) History

In the history menu, the faults detected by the ISOMETER® are displayed.

For a detailed description, refer to "[History memory](#)" on page 40.

- | | |
|----------|---------------------------------------|
| *History | Overview of faults that have occurred |
| *Delete | Reset of the history memory |

8.2 (6) Device settings

The device settings menu allows configuring the basic settings for the ISOMETER®:

8.2 (6.1) Language

Choose the display language of the ISOMETER®. For example, the following languages can be set:

- *Deutsch
- *English
- *...

8.2 (6.2) Clock

In the clock menu, the display format of date and time of the ISOMETER® can be set:

8.2 (6.2.1) Time

Based on the selected time format, set the current time to display 24-hour or 12-hour notation (am/pm).

8.2 (6.2.2) Format (time)

Select the appropriate time format to be displayed:

- | | |
|-------|------------------------|
| *12 h | 12-hour notation am/pm |
| *24 h | 24-hour notation |

8.2 (6.2.3) Summer time

Summer time can be considered in the following settings:

- *off No automatic change between summer time and standard time.
- *DST Daylight Saving Time
Automatic change between summer time and standard time according to North American regulation.
North American summer time begins on each second Sunday in March at 02:00 local time by setting the clock forward by one hour from 2:00 to 03:00 local time. Summer time always ends the first Sunday in October at 03:00 local time by setting the clock back one hour from 3:00 to 2:00.
- *CEST Central European Summer Time
Automatic change between summer time and standard time according to Central European regulation.
Central European summer time begins on each last Sunday in March at 02:00 CEST by setting the clock forward by one hour from 2:00 to 03:00. Central European summer time always ends on the last Sunday in October at 03:00 CEST by setting the clock back one hour from 3:00 to 2:00.

8.2 (6.2.4) Date

Based on the selected date format, the current date can be set.

8.2 (6.2.5) Format (date)

Select the date format to be displayed:

- *dd.mm.yy day, month, year
- *mm-dd-yy month, day, year

8.2 (6.3) Interface

Set the parameters for connection of other devices to the ISOMETER® in the interface menu.

- *Mode
- *BMS
- *Modbus RTU

8.2 (6.3.1) Mode

Set the parameters for the communication with other devices via the BMS bus or Modbus RTU

- *BMS
- *Modbus RTU

8.2 (6.3.2) BMS

8.2 (6.3.2.1) BMS address

Address setting of the BMS bus from 1 to 90.

8.2 (6.3.3) Modbus RTU

8.2 (6.3.3.1) Modbus RTU address

Address setting in the address range from 1 to 247

8.2 (6.3.3.2) Baud rate

- *9.6 kB
- *19.2 kB
- *37.4 kB
- *57.6 kB
- *115 kB

8.2 (6.3.3.3) Parity

- *even
- *odd
- *none

8.2 (6.3.3.4) Stop bits

- *1
- *2
- *auto

8.2 (6.4) Display

Adjust the display brightness for the ISOMETER® in the display menu.

8.2 (6.4.1) Brightness

Adjust the display brightness between 0 % and 100 % in steps of 10.

If no button is pressed on the display for 15 minutes, the brightness of the display decreases.

When a button is pressed, the selected brightness is restored.

8.2 (6.5) Password

Use the password function to protect the device parameters against unauthorised adjustment. The default password is 0000.

8.2 (6.5.1) Password

Enter an individual four-digit password.

8.2 (6.5.2) Status

Decide whether the password query should be used:

*on	Password query active
*off	Password query inactive

8.2 (6.6) Commissioning

In the commissioning menu, the ISOMETER®'s commissioning wizard can be started again.

8.2 (6.7) Factory settings

8.2 (6.8) Service

The service menu can only be accessed by Bender service staff.

8.2 (7) Info

The ISOMETER®'s current settings can be viewed in the info menu. Navigate through the different views using the \wedge and \vee buttons:

*Info - Device	Device name, serial number, article number
*Info - Software	Software version measurement technology, software version HMI
*Info - Measurement technology	Set profile, locating current and EDS mode
*Info - Clock	Time, date, summer time
*Info - BMS	Address of the RS-485 interface

9. Device communication

Over the RS-485 interface of the device, data can be transferred either via the BMS protocol or the Modbus RTU protocol. The protocol and the protocol parameters are set in the "Interface" menu 8.2 (6.3).



Communication with EDS devices

Communication with EDS devices is only possible with the BMS protocol.

9.1 RS-485 interface with BMS protocol

The RS-485 interface, galvanically isolated from the device electronics, serves as a physical transmission medium for the BMS protocol. When an ISOMETER® or other bus-capable devices are interconnected via the BMS bus in a network, the BMS bus must be terminated at both ends with a $120\ \Omega$ resistor. For this purpose, the device is equipped with the terminating switch RS-485 Term. (ON/OFF).

An RS-485 network that is not terminated is likely to become unstable and cause malfunctions. Only the first and last device in one line may be terminated. Hence, stub feeders in the network must not be terminated. The length of the stub feeders is restricted to a maximum of 1 m.

9.1.1 Topology RS-485 network

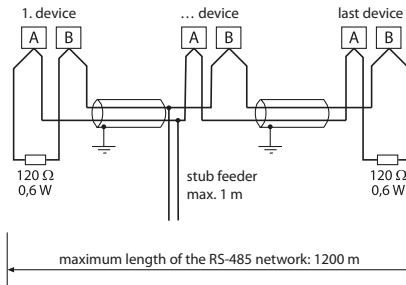

Connection to the terminals A and B.

Termination

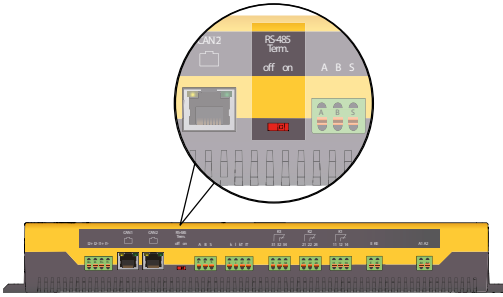

The optimum topology for an RS-485 network is a daisy-chain connection. In this connection, device 1 is connected to device 2, device 2 to device 3, device 3 to device n etc. The RS-485 network represents a continuous path without branches.

Correct arrangement

Three examples for correct arrangement:

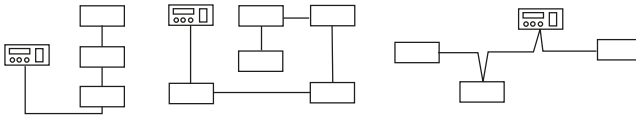

Wrong arrangement

Three examples for wrong arrangement:

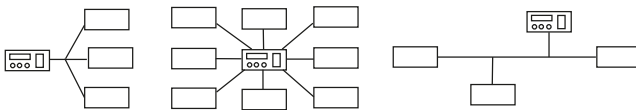

Wiring

The following cable is recommended for wiring the RS-485 network:

Shielded cable, core diameter 0.8 mm (e.g. J-Y(St)Y 2x0.8), shield connected to earth (PE) on one end.

The max number of bus nodes is restricted to 32 devices. If more devices are to be connected, Bender recommends the use of a DI1 repeater.

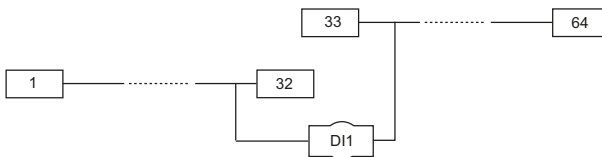

9.1.2 BMS protocol

This protocol is an essential part of the Bender measuring device interface (BMS bus protocol). Data transmission generally makes use of ASCII characters.

Interface data are:

- Baud rate: 9600 baud
- Transmission: 1 start bit, 7 data bits, 1 parity bit, 1 stop bit (1, 7, E, 1)
- Parity: even
- Checksum: Sum of all transmitted bytes = 0 (without CR and LF)

The BMS bus protocol works according to the master-slave principle. Only one master may exist in each network. All bus devices are identified by a unique BMS address. The master cyclically scans all other slaves on the bus, waits for their response and then carries out the corresponding commands.

A device receives the master function by assigning **bus address 1** to it.

9.1.3 BMS master

A master can query all measured values, alarm and operating messages from a slave. If bus address 1 is assigned to a device, this device automatically operates as master, i.e. all addresses between 1 and 150 are cyclically scanned for alarm and operating messages via the BMS bus. If the master detects incorrect answers from a slave, the fault message "Fault RS-485" will be output via the BMS bus.

The following fault causes may exist:

- Addresses are assigned twice
- A second master exists on the BMS bus
- Interference signals occur on the bus lines
- A defective device is connected to the bus
- Terminating resistors are not activated or connected

9.1.4 Commissioning of an RS-485 network with BMS protocol

- Interconnect terminals A and B of all bus devices in one line.
- Switch the terminating resistors on at the start and the end of the RS-485 network. If a device at the end of the bus is not terminated, connect a 120 Ω resistor to terminals A and B.
- Switch the supply voltage on.
- Assign the master function and address 1 to a bus-capable device.
- Assign addresses (2...90) to all other bus devices in consecutive order.

9.1.5 Address setting and termination

Correct address setting and termination is essential for proper functioning of the isoxx1685xx-xxx series insulation monitoring device.



Risk of bus errors!

Double assignment of addresses on the respective BMS busses can cause serious malfunctions.

- Ensure correct address setting and termination of the device!

9.1.6 Setting the BMS address



The ISOMETER® cannot switch on a potential termination at the BMS bus. Even though this is not expected to cause communication problems, the ISOMETER® should be operated as BMS slave if possible (BMS address > 1). If no other device with master capabilities is available on the bus, the ISOMETER® can be set to master (BMS address 1).



Before the ISOMETER® takes over the backup master function after being switched on, it waits to see if another master connects to the system. Waiting period: BMS address minus 1 = waiting period in minutes. Example: The iso1685DP has BMS address 3. It waits 3 minus 1 minutes (= 2 minutes) for a master to connect.

Set the BMS address ((1)2...90) in the device menu via the following path:

Device settings > Interface > BMS > BMS address.

9.1.7 Alarm and operating messages via the BMS bus

Messages are transmitted to a maximum of 12 BMS channels. All alarm and operating messages that may occur are described below.

9.1.7.1 Alarm messages

Alarm	Channel	Description
Alarm 1 (insulation fault)	1	Insulation resistance "Prewarning" (Value < response value 1, $R_F < R_{an1}$)
Alarm 2 (insulation fault)	2	Insulation resistance "Alarm" (Value < response value 2, $R_F < R_{an2}$)
System connection	4	Connection fault system
Connection PE	5	Connection fault earth
Device error	7	Internal device error
Start insulation fault location (isox1685DP only)	9	The insulation fault location is started
Overtemperature coupling	10	Overtemperature coupling terminal L1/+
Overtemperature coupling	11	Overtemperature coupling terminal L2/-
Overtemperature PGH (isox1685DP only)	12	Overtemperature of the locating current injector

9.1.7.2 Operating messages

Alarm	Channel	Description
Insulation resistance	1	Current insulation resistance R_F (when $R_F > (R_{an1} + \text{hysteresis})$)
Insulation resistance	2	Current insulation resistance R_F (when $R_F > (R_{an2} + \text{hysteresis})$)
Leakage capacitance	4	Leakage capacitance C_e in nF, μF
Mains voltage	5	Current system voltage U_N
Partial voltage U+/PE	6	Current partial voltage terminal L1/+ to earth
Partial voltage U-/PE	7	Current partial voltage terminal L2/- to earth
PGH current (isox1685DP only)	8	Current PGH locating current (when EDS system is active)
Temperature coupling	10	Current temperature of the coupling L1/+
Temperature coupling	11	Current temperature of the coupling L2/-
Temperature PGH (isox1685DP only)	12	Current temperature of the locating current injector

9.1.7.3 Resetting error messages

Recorded errors are presented as alarm messages on the BMS bus.

The fault messages are reset via the device menu. If the fault continues to exist, the message will be generated again. The error can also be reset by means of the acknowledgement command via the BMS bus.

9.1.7.4 Error codes

The following list contains all relevant error codes output via the BMS bus. The right-hand column describes the relevant action to be taken in each case.

BMS Error code	Component	Error	Action
0.30	Connection	Connection earth (E/KE)	Check connection
0.40	Connection	System connection (L1/+, L2/-)	Check connection
4.05	Parameter	Incorrect measurement profile selected	Change measurement profile
7.63	System	Timeout system management	Restart the device
8.11	Hardware	Self test insulation measurement	Contact service
8.12	Hardware	Hardware measuring voltage source	Replace device
8.31 (isoxx1685DP only)	Hardware	PGH: locating current too high	Replace device
8.32 (isoxx1685DP only)	Hardware	PGH: locating current cannot be switched off	Replace device
8.42	Hardware	Supply voltage ADC	Replace device
8.43	Hardware	Supply voltage +12 V	Replace device
8.44	Hardware	Supply voltage -12 V	Replace device
8.45	Hardware	Supply voltage +5 V	Replace device
8.46	Hardware	Supply voltage +3.3 V	Replace device
9.61	Parameter	Insulation measurement	Load and reparameterise factory settings
9.63 (isoxx1685DP only)	Parameter	Locating current injector	Load and reparameterise factory settings
9.64	Parameter	Voltage measurement	Contact service

BMS Error code	Component	Error	Action
9.70	System	General software error	Restart the device
9.71	System	Control flow	Restart the device
9.72	System	Programme sequence insulation measurement	Restart the device
9.73 (isoxx1685DP only)	System	Programme sequence locating current injector	Restart the device
9.74	System	Programme sequence voltage measurement	Restart the device
9.75	System	Programme sequence temperature measurement	Restart the device
9.76	System	Programme sequence history memory	Restart the device
9.77	System	Programme sequence console	Restart the device
9.78	System	Programme sequence self test	Restart the device
9.80	System	Stack error	Restart the device
9.81	System	Internal programme sequence	Restart the device
9.82	System	Internal programme sequence	Restart the device

9.2 RS-485 interface with Modbus protocol

Modbus is an internationally widely used protocol for data transfer between devices.

All measured values, messages and parameters are stored in virtual register addresses. Data can be read out with a read command on a register address. With a write command, data can be written into a register address.

The register addresses of the individual measured values and parameters can be found in the "isoxx1685Dx_D00272_00_A_XXDE" manual with the title "ISOMETER® isoxx1685Dx device family - Modbus settings" at <http://www.bender.de/manuals>.

10. Insulation fault location (isoxx1685DP only)

10.1 General description

An additional function of the ISOMETER® in combination with the EDS is the selective insulation fault location. The insulation faults detected in the IT system by the ISOMETER® can be located by means of an EDS and measuring current transformers. For further information regarding the operating principle of the insulation fault location, refer to [3.3.2 "Insulation fault location" on page 15](#).

10.2 Required settings for insulation fault location

Connecting and commissioning the system consisting of ISOMETER® and EDS correctly

For further information regarding the connection of the EDS, refer to [chapter 5.2.3 "Connecting the EDS to the ISOMETER® isoxx1685DP" from page 25](#), and to the corresponding manual of the EDS.

Setting locating current and EDS mode

These settings can be made either during initial commissioning (see [chapter 6.3 "Initial commissioning" from page 31](#)) or in the device menu of the ISOMETER® (see [chapter 8.2 \(2\) "EDS \(insulation fault location only for isoxx1685DP\)" from page 50](#)). For further information regarding the locating current for insulation fault location, refer to [8.2 \(2.1.2\) "Current" on page 51](#). For further information regarding EDS modes, refer to [8.2 \(2.1.1\) "Mode" on page 50](#).

10.3 Indication on the display

The active insulation fault location is shown on the display of the ISOMETER®. For further information, refer to [chapter 7.7 "Insulation fault location" from page 40](#).

10.4 Starting and stopping the insulation fault location

The insulation fault location can be started and stopped via different interfaces:

- Shortcut button "EDS". Permanently start/stop the insulation fault location manually. If the device is started permanently, it will measure until it is stopped manually using the shortcut button. (refer to [chapter 4.3 "Display and operating elements" from page 20](#))
- Device menu
- Digital input

For further information regarding start and stop conditions of the insulation fault location, refer to [8.2 \(2.1.1\) "Mode" on page 50](#).

11. Alarm messages

Alarm message	Description	Action	LED indicators
Alarm 1 (insulation fault)	The insulation resistance is lower than the response value R_{an1}	<ul style="list-style-type: none"> Determine cause of the insulation fault and eliminate it. 	ALARM 1 lights up
Alarm 2 (insulation fault)	The insulation resistance is lower than the response value R_{an2}	<ul style="list-style-type: none"> Determine cause of the insulation fault and eliminate it. 	ALARM 2 lights up
Check L1-L2 for correct connection	Connection fault system	<ul style="list-style-type: none"> Check the wiring of terminals L1/+, and L2/- to the IT system Press the TEST button Check mains voltage Check fuses 	ALARM 1 + ALARM 2 flash in common mode
Check E-KE connections for interruptions	Connection fault. E/KE not connected to PE	<ul style="list-style-type: none"> Check wiring of terminals E and KE to earth (PE) Press the TEST button 	ALARM 1 + ALARM 2 flash in common mode
Device error x.xx	Internal device error	<ul style="list-style-type: none"> Press the TEST button Switch the supply voltage on and off Contact Bender Service 	SERVICE lights up
Overtemperature coupling	Overtemperature coupling terminal L1/+ or L2/-	<ul style="list-style-type: none"> Check mains voltage level and eliminate any existing insulation faults. After cooling down, the device switches on again automatically at a temperature of 80 °C. This device behaviour is normal if a high mains voltage and low insulation fault resistance have been selected. 	SERVICE lights up
Overtemperature PGH (isoxx1685DP)	Overtemperature of the locating current injector	<ul style="list-style-type: none"> Wait for the end of the cool-down period 	SERVICE lights up
Check date and time!	Date and time have not been set yet	<ul style="list-style-type: none"> Set local date and time (in case of voltage failure buffer for three days) 	

12. Technical data

12.1 Device profiles

12.1.1 Power circuits

Main circuits without dynamic frequency changes. The universal profile is suitable for all systems primarily with constant power frequencies and extraneous DC voltages. When using inverters and dynamic frequency control, select Inverter > 10 Hz or Inverter < 10 Hz.

Power frequency	System leakage capacitance	Measuring voltage	Response value range
DC, 15...460 Hz	0...150 μF	$\pm 50\text{ V}$	iso1685DP: 200 Ω ...1 M Ω isoHV1685: 200 Ω ...1 M Ω isoLR1685DP: 20 Ω ...100 k Ω

Diagram „Power circuits“

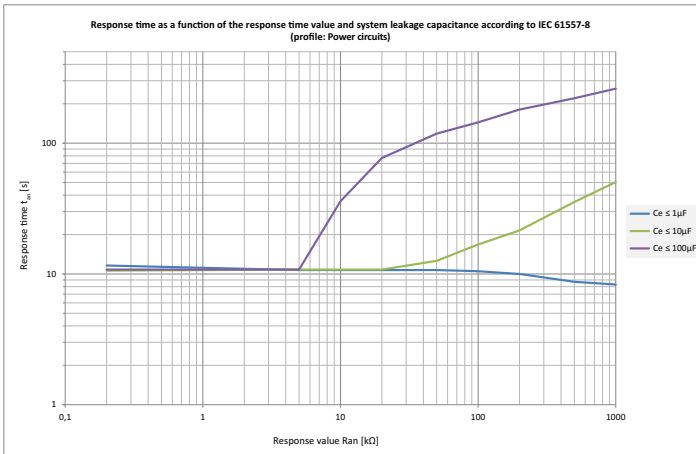

12.1.2 High capacitance

For systems with high leakage capacitances, e.g. ship applications, the impact of leakage capacitances on the measuring result can be significantly reduced by selecting this profile.

Power frequency	System leakage capacitance	Measuring voltage	Response value range
DC, 15...460 Hz	0...500 μF	$\pm 50\text{ V}$	iso1685DP: 200 Ω ...200 k Ω isoHV1685: 200 Ω ...200 k Ω isoLR1685DP: 20 Ω ...20 k Ω

Diagram „High capacitance“

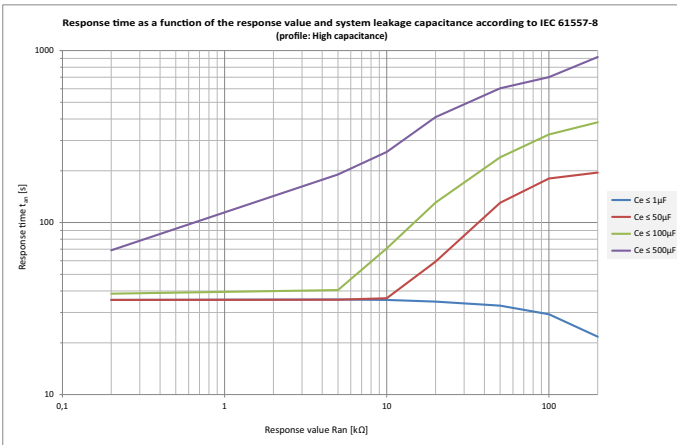

12.1.3 Inverter > 10 Hz

This profile is used for systems with dynamic frequency control by inverters in the range 10 to 460 Hz in order to optimise the measurement with respect to the measuring time and quality.

Power frequency	System leakage capacitance	Measuring voltage	Response value range
DC, 10...460 Hz	0...150 μF	$\pm 50\text{ V}$	iso1685DP: 200 Ω ...1 M Ω isoHV1685: 200 Ω ...1 M Ω isoLR1685DP: 20 Ω ...100 k Ω

Diagram „Inverter < 10 Hz“

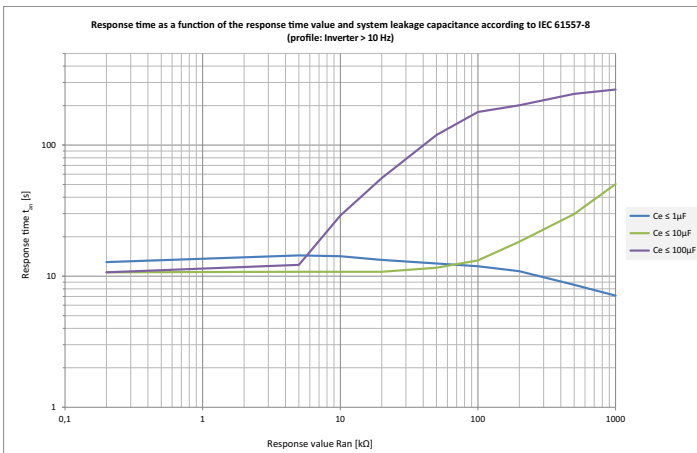

12.1.4 Inverter < 10 Hz

For systems involving extremely low-frequency control in the range of up to 0.1...460 Hz and very slow and continuously changing extraneous DC voltages due to dynamic load conditions in an IT system, continuous insulation monitoring can be optimised using this profile.

Power frequency	System leakage capacitance	Measuring voltage	Response value range
DC, 0.1...460 Hz	0...150 μF	$\pm 50\text{ V}$	iso1685DP: 200 Ω ...1 M Ω isoHV1685: 200 Ω ...1 M Ω isoLR1685DP: 20 Ω ...100 k Ω

Diagram „Inverter > 10 Hz“

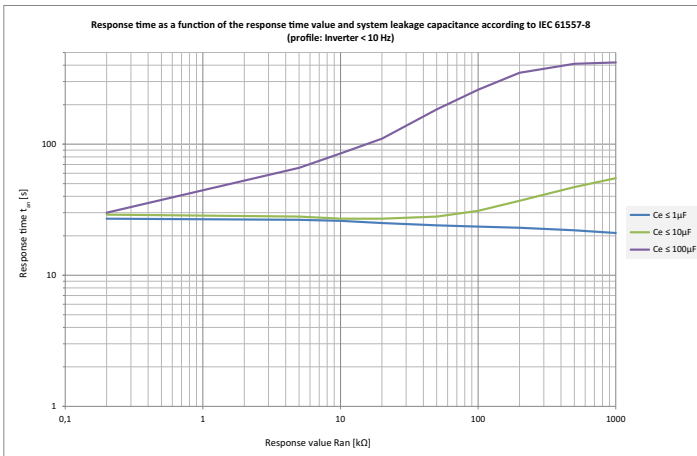

12.1.5 Fast 2000 μF PV

For systems with very high leakage capacitances, e.g. in large-scale photovoltaic systems, this profile ensures correct measurement with the iso1685DP.

Power frequency	System leakage capacitance	Measuring voltage	Response value range
DC, 15...460 Hz	0...2000 μF	$\pm 50\text{ V}$	iso1685DP: 200 Ω ...50 k Ω isoHV1685: 200 Ω ...50 k Ω isoLR1685DP: 20 Ω ...5 k Ω

Diagram „Fast 2000 μF “

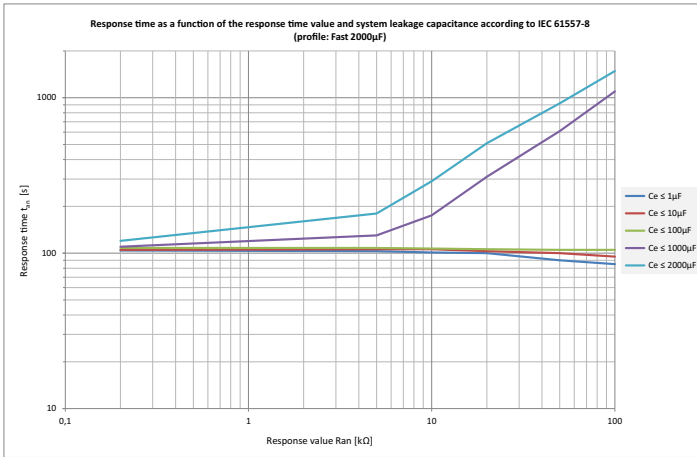

12.2 Diagrams of the leakage capacitance

The determination of the leakage capacitance depends on the size of the insulation resistance. The following diagrams show the relationship.

Example:

Insulation resistance 50 kOhm => min. measurable leakage capacitance 35 μF

Insulation resistance 5 kOhm => min. measurable leakage capacitance 210 μF

Restriction for determining the leakage capacitance (iso1685DP; isoHV1685D)

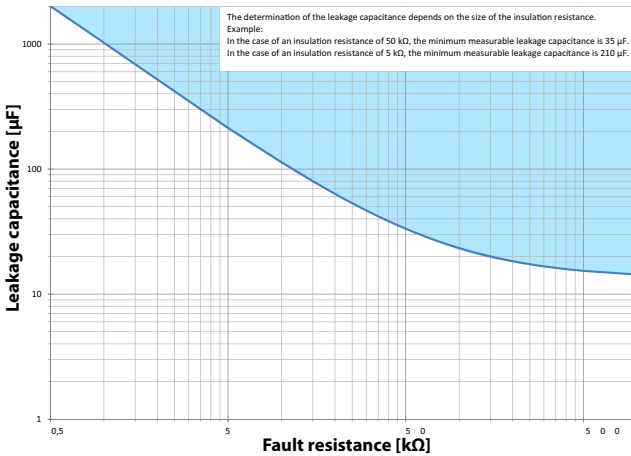

Restriction for determining the leakage capacitance (isoLR1685DP)

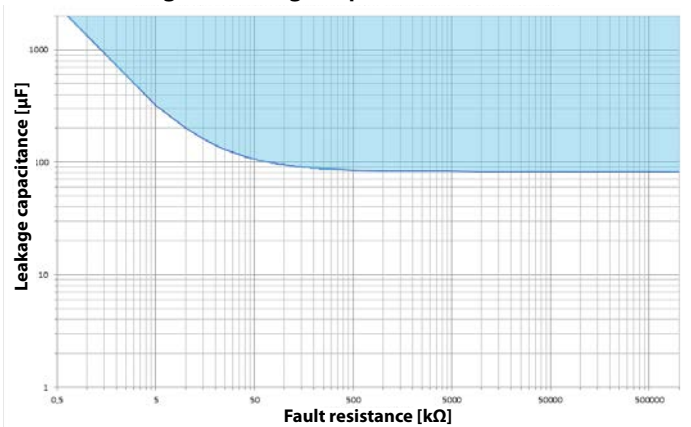

12.3 Factory settings

Parameter	Value
Response values/alarms	
Measurement profile	Power circuits
Response value R_{an1} (ALARM 1)	40 k Ω 4 k Ω for isoLR1685DP-325
Response value R_{an2} (ALARM 2)	10 k Ω 1 k Ω for isoLR1685DP-325
Fault memory	off
Coupling monitoring	on
Switching elements	
Relay 1 (11, 12, 14)	Operating mode: N/C operation Function: Insulation measurement
Relay 2 (21, 22, 24)	Operating mode: N/C operation Function: Insulation measurement
Relay 3 (31, 32, 34)	Operating mode: N/C operation Function: Insulation measurement
Insulation fault location (isoxx1685DP only)	
EDS mode	auto
PGH current	25 mA
BMS	
BMS address	2
BMS termination	ON
Digital inputs	
Digital input 1	Operating mode: active high Function: TEST
Digital input 2	Operating mode: active high Function: STANDBY for isoHR1685D-925: "Initial measurement"
Other	
Standby mode (disconnection from the mains)	off
Permissible system leakage capacitance	depending on the set measurement profile
Buzzer	off
Menu language	Deutsch
Password query	off
Password	0000

12.4 Tabular data isoxx1685Dx-x25

Insulation coordination acc. to IEC 60664-1/IEC 60664-3

Definitions:

Measuring circuit (IC1).....	(L1/+, L2/-), (E, KE)
Supply circuit (IC2).....	A1, A2
Output circuit 1 (IC3).....	11, 12, 14
Output circuit 2 (IC4).....	21, 22, 24
Output circuit 3 (IC4).....	31, 32, 34
Control circuit (IC6).....	(A, B), (I1+, I1-, I2+, I2-)
Rated voltage [for isoHV1685D]	1500 V [3000 V]
Overtoltage category.....	III
Rated impulse voltage:	
IC1 / (IC2-5) [for isoHV1685D]	8 kV [16.670 kV]
IC2 / (IC3-5).....	4 kV
IC2 / IC1+IC6.....	800 V
IC3 / (IC4-6)	4 kV
IC4 / (IC5-6)	4 kV
IC5 / IC6	4 kV
Rated insulation voltage:	
IC1 / (IC2-6) [for isoHV1685D]	1500 V [3000 V]
IC2 / (IC3-5).....	250 V
IC2 / IC6	50 V
IC3 / (IC4-6).....	250 V
IC4 / (IC5-6).....	250 V
IC5 / IC6	250 V
Pollution degree	3
Safe isolation (reinforced insulation) between:	
IC1 / (IC2-5) [for isoHV1685D]	overtoltage category III, 1500 V [3000 V]
IC2 / (IC3-5).....	Overtoltage category III, 300 V
IC2 / IC6	Overtoltage category III, 50 V
IC3 / (IC4-6).....	Overtoltage category III, 300 V
IC4 / (IC5-6).....	Overtoltage category III, 300 V
IC5 / IC6	Overtoltage category III, 300 V
Voltage test (routine test) acc. to IEC 61010-1:	
IC2 / (IC3-5).....	AC 2.2 kV
IC2 / IC6	DC ±0.50 kV
IC3 / (IC4-6).....	AC 2.2 kV
IC4 / (IC5-6).....	AC 2.2 kV
IC5 / IC6	AC 2.2 kV

Voltage ranges

Nominal system voltage range U_n iso1685DP	AC 0...1000 V; DC 0...1500 V
Nominal system voltage range U_n isoHV1685D	AC 0...2000 V; DC 0...3000 V
Nominal system voltage range U_n isoLR1685DP	AC 0...690 V; DC 0...690 V
Tolerance of U_n	AC +10%/DC +5%
Frequency range of U_n	DC 0.1...460 Hz
Supply voltage U_s (see also device nameplate)	DC 18...30 V
Frequency range of U_s	DC
Power consumption	≤ 9 W

Measuring circuit for insulation monitoring

Measuring voltage U_m (peak value)	± 50 V
Measuring current I_m (at $R_F = 0 \Omega$)	≤ 0.7 mA
Measuring current I_m isoLR1685DP (at $R_F = 0 \Omega$)	≤ 3.5 mA
Internal DC resistance R_i iso1685DP	≥ 70 k Ω
Internal DC resistance R_i isoHV1685D (two-pole coupling)	≥ 210 k Ω
Internal DC resistance R_i isoHV1685D (single-pole coupling)	≥ 420 k Ω
Internal DC resistance R_i isoLR1685DP	≥ 15 k Ω *1
Impedance Z_i at 50 Hz iso1685DP	≥ 70 k Ω
Impedance Z_i at 50 Hz isoHV1685D (two-pole coupling)	≥ 210 k Ω
Impedance Z_i at 50 Hz isoHV1685D (single-pole coupling)	≥ 420 k Ω
Impedance Z_i at 50 Hz isoLR1685DP	≥ 15 k Ω *1
Permissible extraneous DC voltage U_{fg}	\leq DC 1600 V
Permissible extraneous DC voltage U_{fg} isoHV1685D	\leq DC 3150 V
Permissible extraneous DC voltage U_{fg} isoLR1685DP	\leq DC 720 V
Permissible system leakage capacitance C_e	profile-dependent, 0...2000 μ F

Response values for insulation monitoring

Response value R_{an1} (Alarm 1) and R_{an2} (Alarm 2)	200 Ω ...1 M Ω
Response value R_{an1} (Alarm 1) and R_{an2} (Alarm 2) isoLR1685DP	20 Ω ...100 k Ω
Condition response value	$R_{an1} \geq R_{an2}$
Upper limit of the measuring range for setting for measurement profile "Fast" $C_{max} = 2000 \mu$ F (isox1685DP only)	50 k Ω
Upper limit of the measuring range for setting for measurement profile "High capacity" $C_{max} = 500 \mu$ F	200 k Ω
Relative uncertainty iso 1685DP	
(10 k Ω ...1 M Ω) (acc. to IEC 61557-8)	± 15 %
(0.2 k Ω ...< 10 k Ω)	$\pm 200 \Omega$ ± 15 %
Relative uncertainty isoHV1685D	
(10 k Ω ...1 M Ω) (acc. to IEC 61557-8)	± 15 %
(0.2 k Ω ...< 10 k Ω)	± 1 k Ω ± 15 %
Relative uncertainty isoLR1685DP	
(1 k Ω ...100 k Ω) (acc. to IEC 61557-8)	± 15 %
(20 Ω ...< 1 k Ω)	$\pm 20 \Omega$ ± 15 %
Hysteresis	25 %

Time response

Response time t_{an} at $R_F = 0.5 \times R_{an}$ ($R_{an} = 10 \text{ k}\Omega$) and $C_e = 1 \text{ }\mu\text{F}$ acc. to IEC 61557-8 profile-dependent, typ. 10 s

Measuring circuit for insulation fault location (EDS) (isoxx1685DP)

Locating current I_L DC $\leq 50 \text{ mA}$ (1/2,5/5/10/25/50 mA)

Test cycle/pause 2 s/4 s

Display

Display Graphic display 127 x 127 pixel, 40 x 40 mm

Display range measured value 200 Ω . . 50 M Ω

Display range measured value isoLR1685DP 20 Ω . . 1 M Ω

LEDs

ON (operation LED) green

PGH ON yellow

SERVICE yellow

ALARM 1 yellow

ALARM 2 yellow

Digital inputs

Operating mode, adjustable active high, active low

Functions off, test, reset, deactivate device, insulation fault location

High level 10 . . 30 V

Low level 0 . . 0.5 V

Serial interface

Interface/protocol RS-485/BMS/Modbus RTU

Connection terminals A/B

Cable length $\leq 1200 \text{ m}$

Shielded cable (shield to functional earth on one end) 2-core, $\geq 0.6 \text{ mm}^2$, e.g. J-Y(St)Y 2x0.6

Shield terminal S

Terminating resistor, can be connected (Term. RS-485) 120 Ω (0.5 W)

Device address, BMS bus (1) 2 . . 90 (2)*

Device address, Modbus RTU 1 - 247

Baud rate 9.6 / 19.2 / 38.4 / 57.6 / 115 kB

Parity even/odd

Stop bits 1 / 2 / auto

Connection (except mains connection)

Connection type pluggable push-wire terminals

Connection, rigid/flexible 0.2 . . 2.5 mm²/0.2 . . 2.5 mm²

Connection, flexible with ferrule, without/with plastic sleeve 0.25...2.5 mm²

Conductor sizes (AWG) 24 . . 12

Mains connection

Connection type.....	pluggable push-wire terminals
Connection, rigid/flexible.....	0.2...10 mm ² /0.2...6 mm ²
Connection, flexible with ferrule, without/with plastic sleeve.....	0.25...6 mm ² /0.25...4 mm ²
Conductor sizes (AWG).....	24...8
Stripping length.....	15 mm
Opening force.....	90...120 N

Switching elements

Switching elements.....	3 changeover contacts:
K1.....	insulation fault alarm 1
K2.....	insulation fault alarm 2
K3.....	device error
Operating principle K1, K2.....	N/C operation or N/O operation
Operating principle K3.....	N/C operation, cannot be changed
Electrical endurance under rated operating conditions, number of cycles.....	100,000
Contact data acc. to IEC 60947-5-1:	
Utilisation category.....	AC 13 / AC 14 / DC-12 / DC-12 / DC-12
Rated operational voltage.....	230 V / 230 V / 4 V / 10 V / 20 V
Rated operational current.....	5 A / 3 A / 1 A / 0.2 A / 0.1 A
Rated insulation voltage.....	250 V
Minimum contact rating.....	1 mA at AC/DC ≥ 10 V

Environment/EMC

EMC.....	IEC 61326-2-4
Classification of climatic conditions acc. to IEC 60721:	
Stationary use (IEC 60721-3-3).....	3K22
Transport (IEC 60721-3-2).....	2K11
Long-term storage (IEC 60721-3-1).....	1K22
Classification of mechanical conditions acc. to IEC 60721:	
Stationary use (IEC 60721-3-3).....	3M11
Transport (IEC 60721-3-2).....	2M4
Long-term storage (IEC 60721-3-1).....	1M12
Deviation from the classification of climatic conditions:	
Ambient temperature during operation iso1685DP, isoLR1685DP.....	-40...+70 °C
Ambient temperature during operation isoHV1685D.....	-40...+55 °C
Ambient temperature transport.....	-40...+80 °C
Ambient temperature long-term storage.....	-25...+80 °C
Area of application.....	≤ 3000 m AMSL

Other

Operating mode	continuous operation
Position of normal use	vertical, mains connection on top
Tightening torque of the screws (4x M5) for enclosure mounting.....	1.0 . . . 1.5 Nm
Degree of protection, internal components.....	IP30
Degree of protection, terminals	IP30
Enclosure material	polycarbonate
Flammability class	V-0
Weight	≤ 1600 g

1.) for $U_n > 500$ V no longer acc. to IEC61557-8

12.5 Standards and certifications

The isoxx1685Dx devices were designed according to the following standards:

- DIN EN 61557-8 (VDE 0413-8)
- IEC 61557-8
- IEC 61557-8 Annex C (for Fast 2000 μ F profile only)
- DIN EN 61557-9 (VDE 0413-9)
- IEC 61557-9 (not for isoHV1685D)
- IEC 61326-2-4
- DIN EN 60664-1 (VDE 0110-1)



12.6 Ordering details

Type	Response value range	Nominal voltage	Supply voltage *	Art. No.
iso1685DP-425	200 Ω ...1 M Ω	AC 0...1000 V DC 0...1500 V	DC 18...30 V	B91065802
isoHV1685D-425	200 Ω ...1 M Ω	AC 0...2000 V DC 0...3000 V	DC 18...30 V	B91065805
isoLR1685DP-325	20 Ω ...100 k Ω	AC 0...690 V DC 0...690 V	DC 18...30 V	B91065803

The values marked with an * are absolute values.

12.7 Change log

Date	Document-version	Software version	Condition / Changes
05/2021	06	iso1685DP-425: D0484 V2.3x isoHV1685D-425: D0588 V2.3x isoLR1685DP-325: D0538 V2.2x	Editorial revision - P 9, Table modified - P. 20, Connection to EDS44x to 3NAC-Systems P 50, factory settings in TD removed - UKCA-Certificate - Change log
08/2022	07	iso1685DP-425: D0484 V2.3x isoHV1685D-425: D0588 V3.1x isoLR1685DP-325: D0538 V2.2x	Editorial revision: - Document DIN A5 / new dimensional drawings - AN with EDS460 removed (discontinuation) - p.26 AN with centre tap added - P.28 AN with IOM441 and EDS44x - Chap. 8.2 New menu items adapted - Chap. 12 Technical data adapted



Bender GmbH & Co. KG

Postbox 1161 • 35301 Grünberg • Germany
Londorfer Str. 65 • 35305 Grünberg • Germany

Tel.: +49 6401 807-0
Fax: +49 6401 807-259

E-Mail: info@bender.de
www.bender.de

Fotos: Bender archive



BENDER Group