





## Table of contents

<b>1</b>	<b>General information.....</b>	<b>6</b>
1.1	How to use the manual.....	6
1.2	Indication of important instructions and information.....	6
1.3	Service and Support.....	6
1.4	Training courses and seminars.....	6
1.5	Delivery conditions.....	6
1.6	Inspection, transport and storage.....	7
1.7	Warranty and liability.....	7
1.8	Disposal of Bender devices.....	7
1.9	Safety.....	8
<b>2</b>	<b>Device features.....</b>	<b>9</b>
<b>3</b>	<b>Function.....</b>	<b>10</b>
3.1	Intended Use.....	10
3.2	Functional description.....	10
3.2.1	Overview.....	10
3.2.2	Connection monitoring.....	11
3.2.3	Manual self test.....	11
3.2.4	Malfunction.....	11
3.2.5	Delay times $t_b$ , $t$ , $t_{on}$ and $t_{off}$ .....	12
3.2.6	Response value monitoring.....	12
3.2.7	Automatic measuring range switching.....	14
3.2.8	Factory settings FAC.....	14
3.2.9	Combined function button (T/R button).....	14
3.2.10	Fault memory.....	14
3.2.11	Channel functions.....	15
3.2.12	Preset function.....	15
3.2.13	Reload function (Automatic fault memory activation).....	16
3.2.14	NFC interface.....	16
3.2.15	Function modules.....	16
<b>4</b>	<b>Dimensions, mounting and connection.....</b>	<b>18</b>
4.1	Dimension diagrams.....	18
4.2	Mounting and removal.....	19
4.3	Connection.....	19
4.3.1	Connections overview.....	19
4.3.2	Supply voltage $U_S$ .....	20

4.3.3	Wiring diagram.....	20
4.3.4	Wiring diagram.....	21
4.3.5	RS-485 interface.....	21
<b>5</b>	<b>Interfaces.....</b>	<b>22</b>
5.1	NFC (Near Field Communication).....	22
5.2	Digital inputs and outputs (overview).....	22
5.3	Digital input and output Q.....	22
5.3.1	Input.....	23
5.3.2	Output.....	23
5.4	Output M+.....	24
5.4.1	Digital mode.....	25
5.4.2	Analogue mode.....	26
5.5	Digital input I.....	27
5.6	Input CT.....	28
5.6.1	Wiring of measuring current transformer type A/type F.....	28
5.6.2	Wiring of measuring current transformer type B/B+.....	29
5.6.3	Suitable measuring current transformers.....	29
5.6.4	Connection of CTs of other manufacturers.....	29
5.6.5	CT1...4 as digital input.....	30
5.7	RS-485 interface.....	30
<b>6</b>	<b>Operation and settings on the device.....</b>	<b>32</b>
6.1	Control panel.....	32
6.2	STATUS LED.....	32
6.3	ALARM LEDs.....	33
6.4	CHANNEL-INDICATION LEDs.....	33
6.5	T/R BUTTON.....	33
<b>7</b>	<b>Modbus interface.....</b>	<b>36</b>
7.1	Device-information registers.....	37
7.2	Alarm/measuring value registers.....	38
7.3	Register monitoring functions.....	39
7.4	Status information registers.....	40
7.5	Harmonic-analysis registers.....	40
7.6	Modbus-parameter registers.....	45
7.7	Registers of digital input "I".....	45
7.8	Registers of input/output "Q".....	46
7.9	Registers of output "M+ ".....	47
7.10	Registers of response-value parameters.....	49

---

7.11	Function and operating-characteristics registers.....	50
7.12	Alarm-behaviour registers.....	51
7.13	Time-behaviour registers.....	51
7.14	Monitoring-functions registers.....	52
7.15	Measuring-current-transformer registers.....	52
7.16	Device-error-code registers.....	53
7.17	Control-commands registers.....	55
7.18	Function-control-commands registers.....	55
<b>8</b>	<b>Error – Cause – Error correction.....</b>	<b>58</b>
<b>9</b>	<b>Technical data.....</b>	<b>59</b>
9.1	Frequency responses of the filters.....	59
9.2	Tabular data.....	61
9.3	Approvals.....	65
9.4	Ordering information.....	66
9.5	Document revision history.....	67

# 1 General information

## 1.1 How to use the manual



### ADVICE

This manual is intended for qualified personnel working in electrical engineering and electronics! Part of the device documentation in addition to this manual is the enclosed supplement "Safety instructions for Bender products".



### ADVICE

Read the operating manual before mounting, connecting and commissioning the device. Keep the manual within easy reach for future reference.

## 1.2 Indication of important instructions and information



### DANGER

Indicates a high risk of danger that will result in death or serious injury if not avoided.



### WARNING

Indicates a medium risk of danger that can lead to death or serious injury if not avoided.



### CAUTION

Indicates a low-level risk that can result in minor or moderate injury or damage to property if not avoided.



### ADVICE

Indicates important facts that do not result in immediate injuries. They can lead to malfunctions if the device is handled incorrectly.



*Information can help to optimise the use of the product.*

## 1.3 Service and Support

Information and contact details about customer service, repair service or field service for Bender devices are available on the following website: [Fast assistance | Bender GmbH & Co. KG](#).

## 1.4 Training courses and seminars

Regular face-to-face or online seminars for customers and other interested parties:

[www.bender.de](http://www.bender.de) > [know-how](#) > [seminars](#).

## 1.5 Delivery conditions

The conditions of sale and delivery set out by Bender GmbH & Co. KG apply. These can be obtained in printed or electronic format.

## 1.6 Inspection, transport and storage

Check the shipping and device packaging for transport damage and scope of delivery. In the event of complaints, the company must be notified immediately, see "[www.bender.de](http://www.bender.de) > service & support."

When storing the devices, observe the information under Environment / EMC in the technical data.

## 1.7 Warranty and liability

Warranty and liability claims for personal injury and property damage are excluded in the case of:

- Improper use of the device.
- Incorrect mounting, commissioning, operation and maintenance of the device.
- Failure to observe the instructions in this operating manual regarding transport, commissioning, operation and maintenance of the device.
- Unauthorised changes to the device made by parties other than the manufacturer.
- Non-observance of technical data.
- Repairs carried out incorrectly.
- The use of accessories or spare parts that are not provided, approved or recommended by the manufacturer.
- Catastrophes caused by external influences and force majeure.
- Mounting and installation with device combinations not approved or recommended by the manufacturer.

This operating manual and the enclosed safety instructions must be observed by all persons working with the device. Furthermore, the rules and regulations that apply for accident prevention at the place of use must be observed.

## 1.8 Disposal of Bender devices

Abide by the national regulations and laws governing the disposal of this device.



Bender GmbH & Co. KG is registered in the waste from electrical and electronic equipment (WEEE) register under the WEEE number: DE 43 124 402. For more information on the disposal of Bender devices, refer to [www.bender.de](http://www.bender.de) > service & support.

## 1.9 Safety

If the device is used outside the Federal Republic of Germany, the applicable local standards and regulations must be complied with. In Europe, the European standard EN 50110 applies.



**DANGER Risk of fatal injury due to electric shock!**

*Touching live parts of the system carries the risk of:*

- Risk of electrocution due to electric shock
- Damage to the electrical installation
- Destruction of the device

Before installing the device and before working on its connections, make sure that the installation has been de-energised. The rules for working on electrical systems must be observed.



## 2 Device features

- AC, pulsed-DC, and smooth-DC sensitive residual-current monitor type A, type F, type B and type B+ according to IEC 62020-1 (depending on the connected measuring-current transformers and activated function modules)
- Measurement modes for each channel: overcurrent (standard), undercurrent, or window mode (out-of-range-values). Every channel can alternatively also be configured as digital input
- One digital input, one digital input/output, and one multifunctional digital/analogue output
- Measurement of the r.m.s. value
- Residual operating current
  - Type A: 6 mA...30 A
  - Type F: 6 mA...30 A (15 Hz...20 kHz)
  - Type B/Type B+: 10 mA...10 A  
(only with function module B "AC/DC sensitive measuring and evaluation of values")
- Separate evaluation of AC/DC (RMS), AC, and DC
- Prewarning: 10...100 % of the residual operating current
- Supply voltage DC 24 V
- Alarm-LED for each channel
- Device status and Alarm LEDs
- Fault-memory behaviour selectable
- RS-485 with Modbus RTU
- NFC interface for device parameter setting via Bender Connect App with the device energised or de-energised
- Continuous CT-connection monitoring
- Sealable transparent cover (optional)
- Expanded functions available by enabling these function modules:
  - AC/DC sensitive measuring and evaluation of values
  - Harmonic analysis (FFT)
  - Connection of Type A external transformers
  - History memory (in preparation)

## 3 Function

### 3.1 Intended Use

The device combination, consisting of RCMS410 and the measuring current transformers intended for it, is designed for AC, DC and pulse-sensitive differential current measurement in TN, TT and IT systems. An RCMS410 sounds an alarm when the adjustable response values are violated.

Please note that, depending on the type of current, further function modules (in particular function module B) must be enabled and activated. For more information, refer to this manual.

Conformity with the product standard DIN EN IEC 62020-1 for residual current measuring devices is only tested and confirmed when an RCMS410 is used in conjunction with the measuring current transformers intended for this purpose (device combination), see "Technical data", page 59. When using third-party transformers, this cannot be generally confirmed.

The requirements of the system and operating conditions on site and the application must be taken into account by selecting a suitable device combination and individual parameterisation. Furthermore, the notes, instructions and specifications in this manual must be observed and implemented.

The devices are designed for use in control cabinets or similarly protected environments.

Any other use, or use beyond this, is regarded as improper.

### 3.2 Functional description

#### 3.2.1 Overview

After the supply voltage  $U_S$  has been applied and the recovery time  $t_b$  has elapsed, the start-up delay  $t$  begins. During the start-up delay  $t$ , no alarms are signalled. The residual current is detected via an external measuring current transformer. If the measured value exceeds the response value of the pre-warning and/or the main alarm, the response delay  $t_{on}$  begins.

After  $t_{on}$  has elapsed, a pre-warning or a main alarm is output via the respective outputs and interfaces and the corresponding alarm LED lights up. If the release value is reached before  $t_{on}$  has elapsed, no alarm is signalled: the LEDs AL1, AL2 Alarm1 and Alarm 2 do not light up and no pre-warning or main alarm is output.

The set delay on release  $t_{off}$  starts when the measured value reaches the release value again after the alarm state has been triggered. When  $t_{off}$  has expired, the device returns to its initial state.

When fault storage is activated, the pre-warning and main alarm are output via the interfaces and LEDs until a reset is carried out. A reset can be carried out via the interface, the digital input or the combined test/reset button (T/R).

Each measuring channel can alternatively be configured as a digital input. In this case, the state of the digital input is output via the interfaces. The functions of  $t_{on}$ ,  $t_{off}$  and fault memory also apply here.

The T/R button can also be used to test the device, switch the NFC function on and off, set write protection and set the Modbus device address.

If the "Start in alarm" function (see Modbus register 32804...32807) is selected for one or more channels, all alarms are set on the corresponding channel during device startup. The alarms are only reset when the device startup is complete and the device is ready to measure, no limit values are violated and no error messages are present.

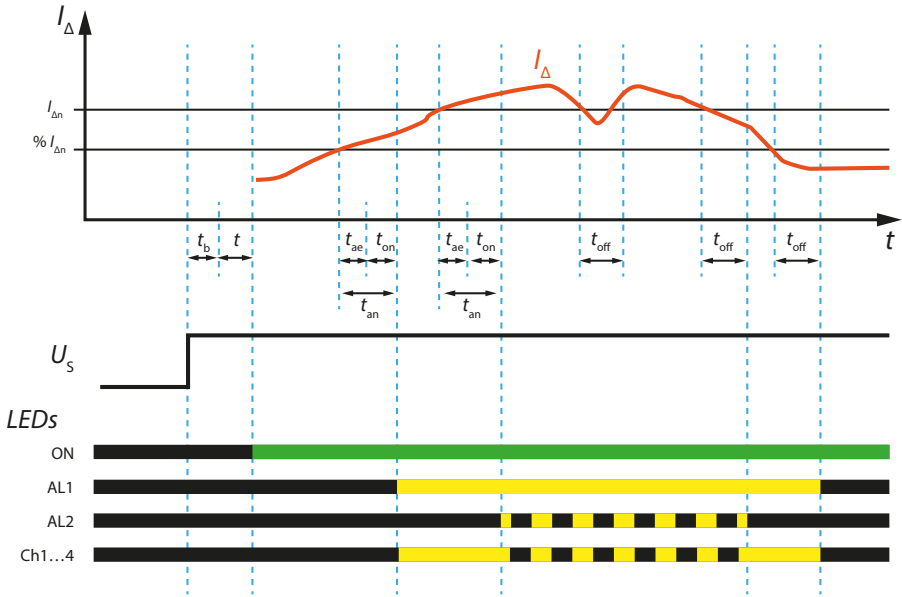

Figure 3-1: Timing diagram

### 3.2.2 Connection monitoring

The connections to the measuring current transformers are permanently monitored.

In the event of a fault, a message is output via the interfaces and the status LED and the channel LED of the faulty connection flash yellow.

The corresponding LEDs flash yellow for this period.

### 3.2.3 Manual self test

When the T/R-button is operated (3...6 s) T-button is operated (> 2 s), the device simulates an alarm status. All LEDs are illuminated, and the outputs are activated. The alarm messages are output via the corresponding interfaces. When the storing of a fault in the memory is enabled, the alarm LEDs and the outputs remain active until the fault memory is cleared by means of a reset.

**i** Users need to carry out the manual self test periodically (at least every 6 months).

### 3.2.4 Malfunction

In the event of an internal malfunction, the status LED changes its colour from green to red or yellow. The error code can be queried via the device interfaces.

### 3.2.5 Delay times $t_{br}$ , $t$ , $t_{on}$ and $t_{off}$

The times  $t_{br}$ ,  $t$ ,  $t_{on}$  and  $t_{off}$  described below delay the output of alarms via LEDs, digital outputs and Modbus RTU.

#### Recovery time $t_b$

The recovery time is the time the device needs to be ready for measurement after the supply voltage  $U_S$  has been connected.

#### Start-up delay $t$

After the supply voltage  $U_S$  has been connected, the measuring function is delayed by the set time  $t$  (0...999 s) plus the recovery time  $t_b$ .

#### Response delay $t_{on}$

If values exceed or fall below the defined residual-operating-current limits, the residual current monitor needs the response time  $t_{an}$  to output the alarm. A set response delay  $t_{on}$  (0...10 s) is added to the device-specific operating time  $t_{ae}$  and delays signalling:

Response time  $t_{an} = t_{ae} + t_{on}$

If the fault does not persist during the response delay, the alarm is not signalled.

#### Delay on release $t_{off}$

If the alarm no longer exists and the storing of a fault in the memory has been disabled, the alarm LEDs go out and the device switches back to the initial status. By means of the delay on release (0...999 s), the alarm state is maintained for the selected period.

### 3.2.6 Response value monitoring

The response value monitoring triggers a pre-warning or a main alarm as soon as the measured value violates the response values for pre-warning or main alarm and can be set individually for each channel. A violation of a response value depends on the set monitoring function (see below) and occurs as soon as a measured value violates a response value at least for the response time  $t_{an}$ . The response time  $t_{an}$  results from the device related operating time  $t_{ae}$  and the adjustable response delay  $t_{on}$  ( $t_{an} = t_{ae} + t_{on}$ ).

The start-up delay time  $t_{on}$  is reset before it has elapsed as soon as the measured value no longer violates the response value.

An alarm (pre-warning or main alarm) is automatically reset as soon as a measured value no longer violates the response value plus a hysteresis for the duration of the delay on release  $t_{off}$ . An activated fault memory function prevents this automatic reset. The delay on release  $t_{off}$  is reset before its expiration as soon as the measured value violates the response value again.

**i** *The delay on release can be extended by up to 2 seconds if the automatic measuring range switchover is activated.*

#### Monitoring function

The monitoring modes available are overcurrent, undercurrent and window.

- The **overcurrent mode** checks whether the measured value exceeds a response value.
- The **undercurrent mode** checks whether the measured value falls below a response value.
- The **window discriminator mode** checks whether the measured value is within a range.  
Lower limit: response value of the pre-warning  
Upper limit: response value of the main alarm

- i Undercurrent mode**  
 Set the response value for the pre-warning higher than the response value for the main alarm ( $\geq 110\%$ ).

### Response values

Depending on the type of transformer connected, the following response values are available for the pre-warning and the main alarm. The response value for the main alarm is set as an absolute value, while the response value for the pre-warning is set as a percentage of the response value for the main alarm.

Measured value/CT type	Type A	Type B
RMS	Yes	Yes
AC	No	Yes
DC	No	Yes



### ADVICE

If the response values are too far apart, this has a negative effect on the measurement accuracy and can trigger a device error ("Invalid CT setting", error code 4.75...7.78).

Even if you only want to monitor the RMS value with a "Type B" measuring current transformer, always set the **AC and DC values to the same values as the RMS values** for the pre-warning and main alarm.

It is essential that you follow the previous instruction when using the window discriminator mode in combination with a "Type B" measuring current transformer!

### Alarm signalling

The signalling of an alarm (pre-warning, main alarm) is carried out

- via the alarm LED(s)
- via message assignment using an output (Q, M+, K1)
- per Modbusregister für Alarm- und Messwerte (Register 999...1044)

### Settings

Parameter	Adjustable per channel	Modbus register
Main alarm response values	Yes	32600...32622
Pre-warning response values	Yes	32624...32635
(Monitoring) Function	Yes	32700...32702
Hysteresis	Yes	32703...32707
Response delay $t_{on}$	Yes	32902...32908
Delay on release $t_{off}$	Yes	32910...32916
Type of measuring current transformer	Yes	33100...33103

### 3.2.7 Automatic measuring range switching

The RCMS410 device measures at least 5 times the set residual operating current ( $5 \times I_{\Delta n}$ ).

However, once ( $5 \times I_{\Delta n}$ ) is reached, no measured value is displayed; instead, only the fact that this limit has been exceeded is reported. If the measuring range switch is enabled, larger measured values can also be output as values.

Measured value	Auto range switching	
	disabled	enabled
$\leq (5 \times I_{\Delta n})$	Output measured value	Output measured value
$> (5 \times I_{\Delta n})$	Output „>“	Output measured value

**i** Automatic measuring range switching is only available in combination with **type A** measuring current transformers and the **overcurrent mode**, see chapter “Response value monitoring”, page 12.

**i** The delay on release  $t_{off}$  can be extended up to 2 s if automatic measuring range switching is enabled.

Parameter	Adjustable per channel	Modbus register	Value
Automatic measuring range switchover	yes	32715...32718	enabled   disabled

### 3.2.8 Factory settings FAC

There are two ways to carry out a reset:

#### Factory settings without interface

After restoring the factory settings, all previously changed settings are reset to the state upon delivery. The settings for the Modbus interface are not reset.

#### Factory settings with interface

After restoring the factory settings, all previously changed settings including the settings for the Modbus interface and the device address are reset to the state upon delivery.

**i** These settings are configured in Modbus registers 60000...60003, function 4.

### 3.2.9 Combined function button (T/R button)

**Reset** = pressing the T/R button 1...3 s

**Test** = pressing the T/R button 3...6 s

**NFC** = pressing the T/R button 6...10 s

**Addr.** = pressing the T/R button 10...15 s

### 3.2.10 Fault memory

The storing of a fault in the memory can be enabled or disabled. When the fault memory is enabled, stored alarms can be reset by performing a reset. The storing of a fault in the memory is factory-set to disabled.

### 3.2.11 Channel functions

**i** *The settings for the channel functions are configured in Modbus registers 32700...32703.*

#### Measuring-current-transformer connection

For each channel either the overcurrent, undercurrent, or window function can be selected (register content 32700...32703: 1, 2, or 3)

- **Overcurrent function**

Prewarning when measured value > prewarning response value or main alarm when measured value > main alarm response value  $I_{\Delta n}$

- **Undercurrent function**

Prewarning when measured value < prewarning response value or main alarm when measured value < main alarm response value  $I_{\Delta n}$

**i** *Note that with the **undercurrent function** the response value of the prewarning is higher than the main alarm response value  $I_{\#r}$ . See Modbus register table for an explanation on how to proceed.*

- **Window mode**

An alarm is given when the values fall or rise outside the range formed by the response values for a prewarning and for a main alarm  $I_{\Delta n}$

**i** *The settings for the response values are configured in Modbus registers 32600...32635.*

#### CT1...4 as digital input

Every measuring channel can alternatively also be configured as digital input (content of registers 32700...32703: 4 or 5). In this event, the status of the digital input is output via the interfaces. For details see chapter "CT1...4 as digital input", page 30.

#### Disabling unused channels

When a measuring channel is not connected, it must be disabled (content of registers 32700...32703: 6).

### 3.2.12 Preset function

With the adjustable preset function default values of the response values can be set for all channels.

For this, the currently measured value is taken into account for every channel. The response value is calculated by multiplying the currently measured value with a preset factor and then adding a preset offset value.

$$I_{\Delta n} = I_{\Delta} \times \text{preset factor} + \text{preset offset}$$

The maximum response value that can be set using the PRESET function is 10 A.

**i** *These settings are configured in Modbus registers 32713 and 32714.*

### 3.2.13 Reload function (Automatic fault memory activation)

The reload function can be set separately for each output.

When faults occur only for a limited time but repeatedly in the monitored system while the storing of faults in the memory is disabled, the alarm outputs would switch over to the fault status simultaneously. The reload function permits limiting the number of these switch-overs. As soon as the specified number is reached, the alarm message at the respective output remains active, and switch-overs are suspended until a reset is performed (= fault memory). When an adjustable time period has passed between two alarms, the counter is reset, while the alarm message does not remain active.

**i** *The settings for this are performed in Modbus registers  
32418 and 32419 (input/output Q)  
32520 and 32521 (output M+)  
32117 and 32118 (relay K1)*

### 3.2.14 NFC interface



The NFC interface can be used to transmit a previously configured device parameter setting directly to the device.

**i** *This function is available only via the Bender Connect App. You can find this app in the Appstores for [iOS](#) and [Android](#).*



In the Bender Connect app the device first needs to be made known. Then the device-specific setting options are shown so that they can be configured. When the data is transferred, feedback is given whether the parameter configuration has been successful. Parameter settings can be transmitted to the device via the Bender Connect app by holding the mobile phone close to the device.



To a **de-energised** device, a parameter setting can be transferred via the Bender Connect app. This setting is then activated automatically when the device is connected to the current supply.



When a device is **plugged in**, too, parameters can be configured via the Bender Connect App. To this end, the NFC interface first needs to be activated in the device.

The NFC antenna is located at the front on the righthand side of the RCMS410.

The NFC interface is activated via the T/R button at the front of the device or via the Modbus interface.

### 3.2.15 Function modules

To expand its application range, optionally function modules can be enabled for the RCMS410. These function modules can be ordered and activated both when first ordering the device and also later on.

#### Function module A: Harmonic analysis (FFT)

Function module A permits analysing harmonics.

**i** *With ordering number B84604042 the harmnoic analysis is already enabled as a default.*



**Function module B: AC/DC sensitive measuring and evaluation of values**

All RCMS410 devices evaluate measuring-current transformers of the types "A" and "F". With function module B also measuring-current transformers of the types "B" and "B+" can be used.

**i** *With ordering numbers B84604041 and B84604042 the AC/DC-sensitive measuring and evaluation of values is already enabled as a default.*

**ADVICE**

If the function module B is activated at a later date, the settings for each channel under  Settings > Measuring points > Channel must be checked and adjusted.

**Function module C: Connection of Type A external current transformers**

Function module C permits the use of measuring-current transformers by manufacturers other than Bender. When an external current transformer is used, a number of turns must be selected in the corresponding Modbus register (33104...33107).

**i** *With ordering number B84604042 the connection of external current transformers is already enabled as a default.*

**Function module D: History memory (in preparation)**

## 4 Dimensions, mounting and connection



Only skilled persons are permitted to carry out the work necessary to install, put into service and run a device or system.



### **DANGER Risk of fatal injury due to electric shock!**

Touching live parts of the system carries the risk of:

- Risk of electrocution due to electric shock
- Damage to the electrical installation
- Destruction of the device

Before installing the device and before working on its connections, make sure that the installation has been de-energised. The rules for working on electrical systems must be observed.

### 4.1 Dimension diagrams

Dimensions in mm

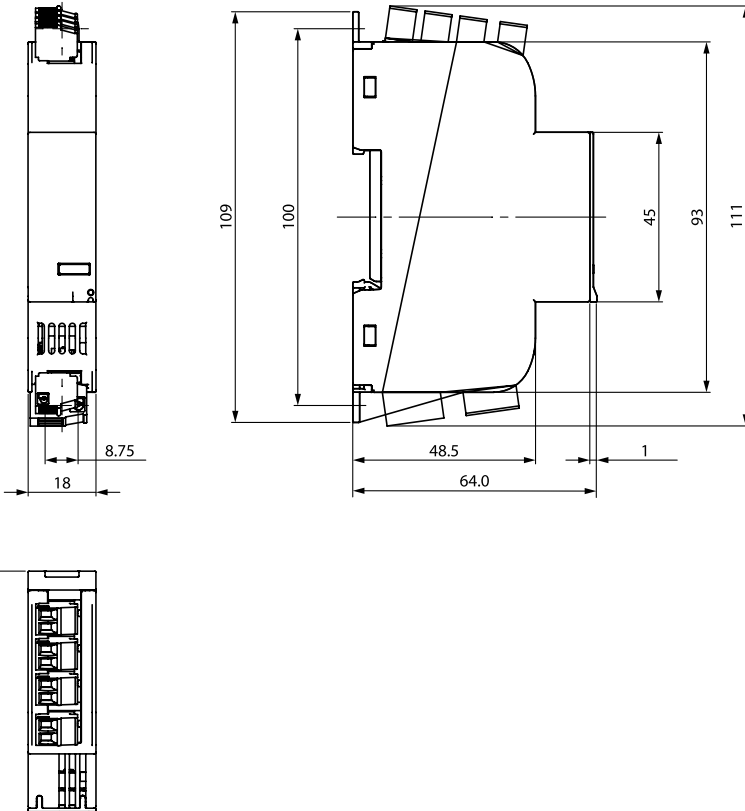

## 4.2 Mounting and removal

### DIN rail mounting

Mounting

Removal

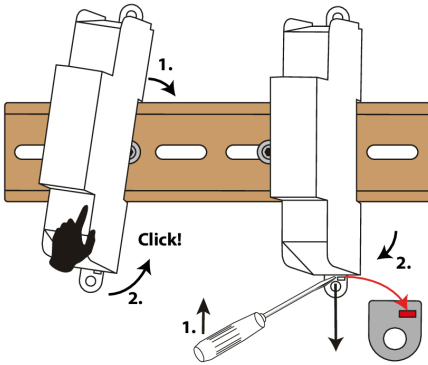

### Screw mounting

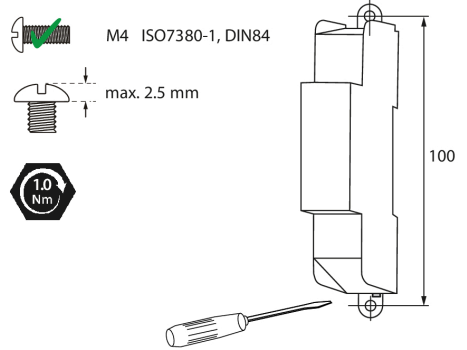

## 4.3 Connection

### 4.3.1 Connections overview

		Terminal	Description
Top		S1, S2 (CT1)	Measuring-current transformer CT1
		S1, S2 (CT2)	Measuring-current transformer CT2
		S1, S2 (CT3)	Measuring-current transformer CT3
		S1, S2 (CT4)	Measuring-current transformer CT4
Bottom		+	Supply voltage DC
		-	
		A	RS-485 A - Modbus RTU
		B	RS-485 B - Modbus RTU
		ON (R)	Termination of RS-485 interface
		M+	Multifunctional output
		Q	Digital input/output
		I	Digital input
	GND		

The cables are connected to the device via plug-in terminals. The maximum permissible conductor cross section is 1.5 mm<sup>2</sup>.

### 4.3.2 Supply voltage $U_S$

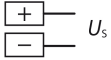

The technical data must be observed.  
The wiring is done on the **bottom** of the device.

**i** Only power supply units of protection classes 2 or 3 are to be used.

### 4.3.3 Wiring diagram

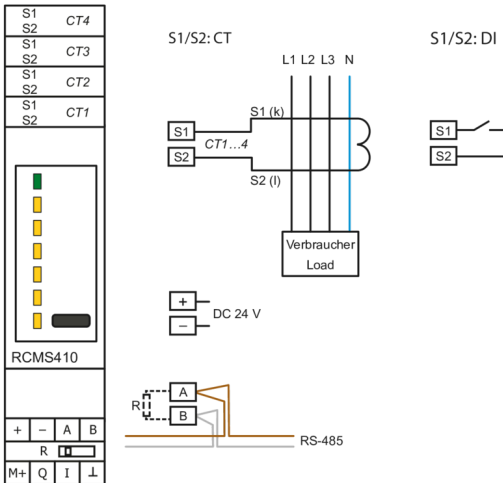

Legend for wiring diagram

- S1/S2: CT      Measuring-current-transformer connection
- S1/S2: DI      CT1...4 as digital input
- +, -          Supply voltage connection
- A, B          RS-485; for details see "RS-485 interface", page 30

**i** RCMS410 and all connected CTUB102-CTBCxx devices must be supplied from the same power supply. Ensure that the 24-V-DC supply is connected correctly. Otherwise the RCMS410 can be destroyed!  
**For UL applications:** Use 60/75 °C copper conductors only!

Cable lengths to the measuring current transformer: See technical data.

### 4.3.4 Wiring diagram

#### AC/DC 100...240 V

Back-up fuse for  $U_S$ : 6 A

Cable lengths to the measuring current transformer: See technical data.

### 4.3.5 RS-485 interface

#### Specification

The RCMS410 has an RS-485 interface with Modbus RTU protocol. In a system setup it is therefore compatible with other Modbus RTU-capable device series from Bender, such as e. g. the RCMB300 series, RCMS150-01, and RCMB13...-01.

Up to 247 Modbus-RTU devices can be used on the bus.

The RS-485 specification restricts the cable length to 1200 m and requires a daisy chain connection.

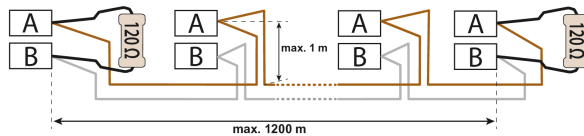

A twisted-pair, shielded cable must be used as bus cable. For example, cable type J-Y(St)Y n x 2 x 0.8 mm<sup>2</sup> is suitable. The shield must be connected to PE at one end.

**i** *If there are more than 16 bus devices, the interface must be designed to be shockproof, because the maximum permissible total leakage current of 0.5 mA is exceeded.*

#### Termination

The bus cable must be terminated at both ends with resistors (120 Ω, > 0.25 W).

A terminating resistor is installed in the device and can be enabled or disabled with the DIP switch at the underside of the housing.

## 5 Interfaces

### 5.1 NFC (Near Field Communication)



The NFC interface can be used to transmit a previously configured device parameter setting directly to the device.



*This function is available only via the Bender Connect App. You can find this app in the Appstores for [iOS](#) and [Android](#).*



In the Bender Connect app the device first needs to be made known. Then the device-specific setting options are shown so that they can be configured. When the data is transferred, feedback is given whether the parameter configuration has been successful. Parameter settings can be transmitted to the device via the Bender Connect app by holding the mobile phone close to the device.



To a **de-energised** device, a parameter setting can be transferred via the Bender Connect app. This setting is then activated automatically when the device is connected to the current supply.



When a device is **plugged in**, too, parameters can be configured via the Bender Connect App. To this end, the NFC interface first needs to be activated in the device.

### 5.2 Digital inputs and outputs (overview)

	Element	Explanation
	Q	<b>Digital input/output</b> <ul style="list-style-type: none"> <li>Input: Execute test or reset</li> <li>Output: Common alarm according to alarm assignment</li> </ul>
	M+	<b>Multi-functional output</b> <ul style="list-style-type: none"> <li>Digital output: Common alarm according to alarm assignment</li> <li>Analogue voltage or current output: For the direct connection of analogue instruments that analyse and display measured values.</li> </ul>
	I	<b>Digital input</b> Execute test and/or reset, configurable with low-active and high-active.
	⊥	<b>GND</b> connection of the inputs/outputs

***i** When commissioning the system, an output signal should be verified by an alternative method (e.g. Modbus interface or the behaviour of another output). In general, redundant monitoring (e.g. using the interface or another output) is recommended when using the analogue/digital outputs.*

### 5.3 Digital input and output Q

Settings in registers 32400...32419

Q is a configurable digital input and output with reference to GND of the measuring sensor's inputs/ outputs.

When it is used as an **input**, a test or reset can be triggered (register 32401).

When it is used as an **output**, the following alarms can be assigned via the alarm assignments (registers 32402...32417):

Prewarning (AL1) AC/DC/RMS CH1...4	The output becomes active if AL1 of the selected measuring channel is present.
Main alarm (AL2) AC/DC/RMS CH1...4	The output becomes active if AL2 of the selected measuring channel is present.
CT-connection fault CH1...4	The output becomes active if a CT-connection fault (short circuit or interruption) of the selected measuring channel is present.
Overloading of the measuring channels	The output becomes active if the measuring function no longer works properly since the residual current is too high.
Device error	The output becomes active when a device error is present.
Test	The output becomes active in the course of a manual self test in accordance with the test process.

The reload settings (number of repeated connection attempts) are configured in registers 32418 and 32419.

### 5.3.1 Input

The following settings can be assigned to input Q:

**High-active:** Event is carried out, when the digital input undergoes a signal change from low to high.

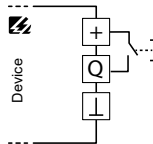

**Low-active:** Event is carried out, when the digital input undergoes a signal change from high to low.

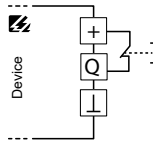

### 5.3.2 Output

The output Q can be operated in the modes Active, Passive or Permanent. The following settings can be assigned:

**High-active:** In the active mode +24 V are internally applied to output Q.

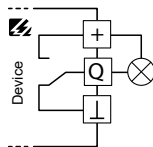
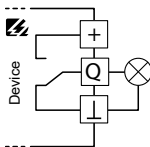

**Low-active:** In the active mode the GND potential is applied to output Q.



In the **passive mode** an external voltage can be connected (see Technical data). The output switches the applied potential to GND.

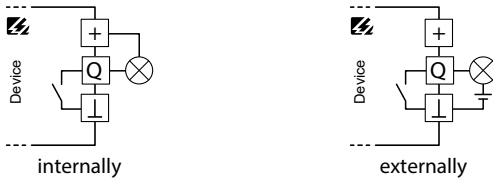

**Permanently high:** The output is permanently set to +24 V.

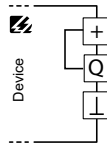

**Permanently low:** The output is permanently switched to GND. In this manner e. g. an additional reference for the digital input can be created.

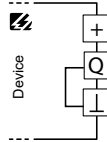

## 5.4 Output M+

M+ is a multifunctional digital/analogue output with reference to GND.



### 5.4.1 Digital mode

Settings in registers 32500...32501

In digital mode, M+ can be operated in Active, Passive or Permanent mode. The following settings can be assigned:

#### M+ = Active

High-active: In the active mode +24 V are applied to output M+ internally.

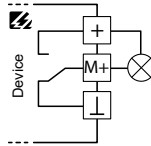
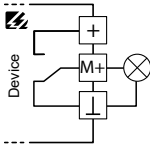

Low-active: In the active mode the GND potential is applied to output M+.

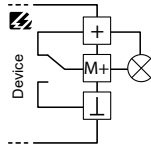
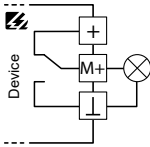

#### M+ = Passive

In the passive mode an external voltage can be connected (see Technical data). The output switches the applied potential to GND.

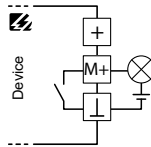
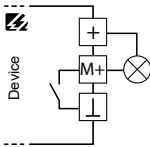

#### M+ = Permanently high

The output is permanently set to +24 V.

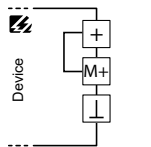

**M+ = Permanently low**

The output is permanently switched to GND. In this manner e. g. an additional reference for the digital input can be created.

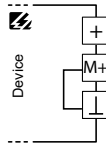

Alarm assignments permit assigning the following alarms to the output M+ in digital mode (registers 32504... 32519):

Prewarning (AL1) AC/DC/RMS CH1...4	The output becomes active if AL1 of the selected measuring channel is present.
Main alarm (AL2) AC/DC/RMS CH1...4	The output becomes active if AL2 of the selected measuring channel is present.
CT-connection fault CH1...4	The output becomes active if a CT-connection fault (short circuit or interruption) of the selected measuring channel is present.
Overloading of the measuring channels	The output becomes active if the measuring function no longer works properly since the residual current is too high.
Device error	The output becomes active when a device error is present.
Test	The output becomes active in the course of a manual self test in accordance with the test process.

The reload settings (number of repeated connection attempts) are configured in registers 32520 and 32521.

**5.4.2 Analogue mode**

Settings in registers 32500...32503

The RMS value of a channel (CH1...4) is allocated to M+ as analogue output. Here a DC voltage or DC current signal that is proportional to the measured value is present at the output. The maximum scale value can be configured. The following settings can be assigned:

Current output: 0-20/4-20 mA

Voltage output: 0-10/2-10 V

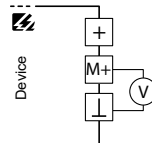
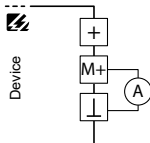

The maximum scale value corresponds to  $I_{\Delta n \text{ RMS}}$  or it can be set at will up to  $5 \times I_{\Delta n}$ , max. 65 A. The overview shows how the measured values  $I_{\Delta}$  (A) of the output signals (in A or V) are shown as proportional values.

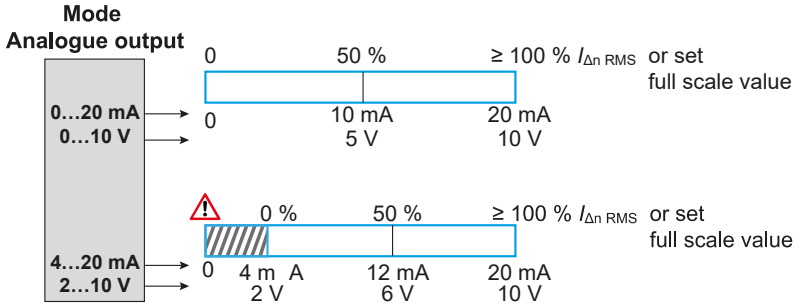

**i** Explanation to  in the diagram:  
In the 4...20 mA or 2...10 V mode an output value of 0 mA or 0 V is a sign of a wiring fault of the analogue interface.

### 5.5 Digital input I

Settings in registers 32300...32301

The digital input "I" can read the status of a potential-free contact.

The digital input "I" can trigger either a test, a reset or the combined function T/R (register 32301). As with the test and reset function of the T/R-button, the combined function T/R is located at the front.

Example (high-active mode)

Closing the contact and opening it within 1...3 s.	Activates the reset function.
Closing the contact and opening it within 3...6 s.	Activates the test function.
Closing the contact and not opening it again (faulty contact).	No function change. A faulty switch can be detected immediately!

**i** The NFC, address setting, and protect functions are not activated via this input.

The following settings can be assigned to input I:

**High-active:** Event is carried out, when the digital input undergoes a signal change from low to high.

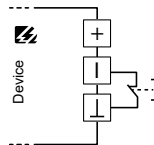

**Low-active:** Event is carried out, when the digital input undergoes a signal change from high to low.

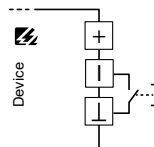

**i** The response delay and the delay on release of the digital input are set to 100 ms each.

## 5.6 Input CT

### 5.6.1 Wiring of measuring current transformer type A/type F

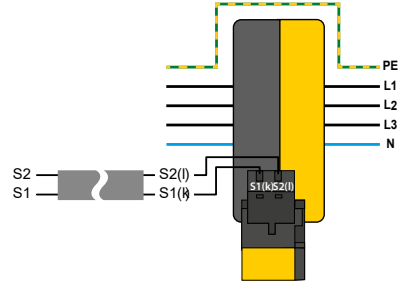
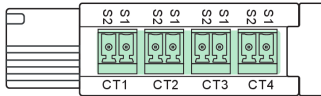

Measuring current transformers "Type A/Type F"



**CAUTION** High-frequency residual currents (>10 kHz) through any connected residual current transformer can cause crosstalk on all channels to which a CTUB102-CTBCxx is connected.

*These channels may experience false tripping at low response values.*

*The effect can be minimised by routing the cables as specified in the transformer installation instructions.*

**i** Ensure that the measuring current transformers are wired correctly. The wiring of S1 is to be connected to the 'S1' (k) connection of the measuring current transformer. S2 must be connected to the 'S2' (l) connection of the measuring current transformer.

**i** For more information on the wiring of measuring current transformers, please refer to the relevant manuals for the measuring current transformers. The installation instructions provided there must be observed.

**i** **For UL applications:**  
The measuring current transformers must be connected to the monitoring device before operation.

### 5.6.2 Wiring of measuring current transformer type B/B+

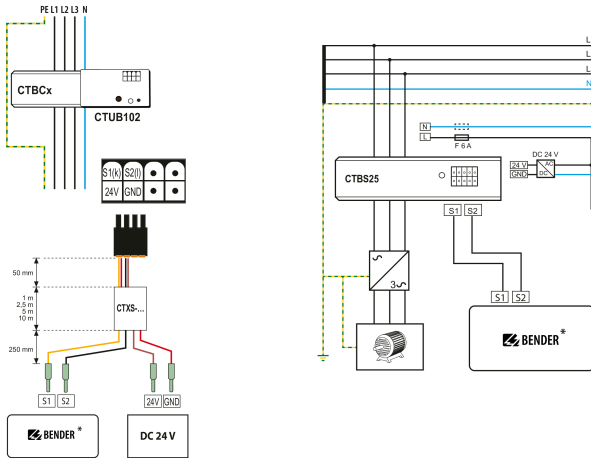

\* = RCMS...

### 5.6.3 Suitable measuring current transformers

Type B/Type B+		Type A/Type F	Type A			
CTBS	Series CTUB	Series CTAC	Series CTAS	Series Wx	Series WR	Series WS
CTBS25	CTUB102-CTBC20(P) CTUB102-CTBC35(P) CTUB102-CTBC60(P) CTUB102-CTBC120(P) CTUB102-CTBC210(P)	CTAC20 CTAC35 CTAC60 CTAC120 CTAC210	CTAS50 CTAS50/01 CTAS80 CTAS80/01 CTAS120 CTAS120/01	W0-S20 W1-S35 W2-S70 W3-S105 W4-S140 W5-S210	WR70x175S WR115x305S WR150x350S WR200x500S WR70x175SP WR115x305SP WR150x350SP WR200x500SP	WS20x30 WS50x80 WS50x80S WS80x120 WS80x80S WS80x120S WS80x160S

### 5.6.4 Connection of CTs of other manufacturers

Third-party current transformers "Type A" can only be used with function module C activated. The numbers of windings of the third-party current transformers must be specified (register 33104...33107).

**i** With ordering number B84604042 the connection of external current transformers is already enabled as a default.

Use residual current transformers and not load-current transformers.

#### Response range

The maximum response range is 6 mA ... 30 A. The actual upper limit of the response range depends on the number of turns n of the measuring-current transformer used:

Upper limit of response range<sub>new</sub> = 30 A x n/600

**Measuring range**

The upper limit of the measuring range depends on the number of turns  $n$  of the measuring-current transformer used:

Measuring range upper limit<sub>new</sub> = measuring range indicated on the datasheet<sup>1)</sup> x  $n/600$

**Continuous residual current**

The permissible continuous residual current depends on the number of turns  $n$  of the measuring current transformer used:

permissible continuous residual current<sub>new</sub> = permissible secondary current<sup>1)</sup> x  $n$

<sup>1)</sup> see "Tabular data", page 61

**i** *Compliance with the respective product standard under chapter "Approvals", page 65 cannot be ensured if an external transformer is used and, if necessary, needs to be assessed separately after consultation with the manufacturer.*

**5.6.5 CT1...4 as digital input**

Settings in the registers 32700...32703

The inputs CT1...4 can alternatively also be used as digital inputs. In this event, the following technical conditions must be met:

- The values of a potential-free contact are read in.
- < 10 Ω: open;
- > 100 Ω: closed;
- Current via switching contact: 0.6 mA.

The behaviour depends on the mode set (high-active or low-active):

- When the contact is closed with high-active: main alarm
- When the contact is opened with low-active: main alarm

With a main alarm the rms-value (min., max., and avg.) is output as 1, if there is no alarm as 0. For an alarm to be output correctly at the corresponding interfaces the corresponding RMS alarm assignment must be enabled.

**5.7 RS-485 interface**

**Spezifikation**

The device has an RS-485 interface with Modbus RTU protocol. In a system setup it is therefore compatible with other Modbus RTU-capable device series from Bender, such as e. g. the RCMB300 series, RCMS150-01, and RCMB13...-01. Up to 247 Modbus-RTU devices can be used on the bus.

The RS-485 specification restricts the cable length to 1200 m and requires a daisy chain connection.

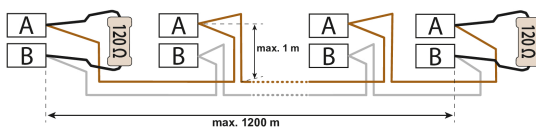

As bus cable a twisted-pair, shielded cable, shield on one side to PE, must be used. CAT6/CAT7 or J-Y(St)Y min. 2 x 0.8 are suitable.

**i** *If there are several devices with their own power supply units on the bus, protection against direct contact shall be ensured, as the maximum permissible total leakage current of 0.5 mA can be exceeded.*

**Termination**

The bus line must be terminated at both ends with resistors (120  $\Omega$ , > 0.25 W).

A terminating resistor is installed in the device and can be enabled or disabled with the DIP switch at the underside of the housing.

## 6 Operation and settings on the device

### 6.1 Control panel

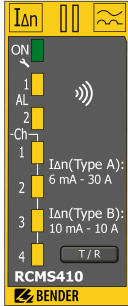

Control panel	Meaning
ON/	STATUS LED Operating mode
AL1	ALARM LED Pre-warning
AL2	ALARM LED Main alarm
Ch 1...4	CHANNEL DISPLAY LEDs of measuring current transformers 1...4
T/R	Test/reset button

### 6.2 STATUS LED

Multicoloured display of various operating modes.



LED	Operating mode
Green	START PHASE Device booting after start NORMAL OPERATION Device in fault-free state
Yellow, flashing	CT FAULT Connection fault measuring current transformer The LED flashes synchronously with the LED of the respective faulty measuring current transformer.
Yellow	DEVICE ERROR reversible Troubleshooting required.
Red	DEVICE ERROR irreversible Device replacement required.
Blue, flashing (frequency approx. 2 s)	NFC ACTIVE



### 6.3 ALARM LEDs

Display of prewarning AL1 and main alarm AL2

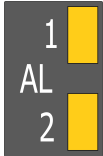

LED	Operating state
AL1	PRE-WARNING Lights up continuously when the pre-warning threshold has been exceeded on a channel.
AL2	MAIN ALARM Flashes when the residual-operating-current threshold $I_{\Delta n}$ has been exceeded on a channel.

### 6.4 CHANNEL-INDICATION LEDs

Channel indication in relation to the residual operating current  $I_{\Delta n}$

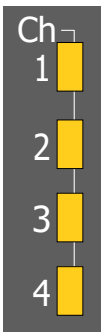

LED Ch	Operating mode
1	Measuring channel LED: <ul style="list-style-type: none"> <li>Lights up continuously when the prewarning threshold has been exceeded.</li> <li>Flashes in time with the AL2 LED when the residual-operating-current threshold <math>I_{\Delta n}</math> has been exceeded or when it is used as a digital input and there is a main alarm.</li> <li>Flashes in time with the STATUS LED when a measuring-current-transformer connection fault is present at the corresponding channel.</li> </ul>
2	
3	
4	

### 6.5 T/R BUTTON

The T/R button activates different operating modes depending on how long it is pressed.



Mode	Operating time	STATUS LED
RESET	1...3 s	flashes yellow
TEST	3...6 s	flashes red
NFC	6...10 s	flashes blue
ADDR	10...15 s	flashes green
PROTECT	20...25 s	flashes violet

## Overview

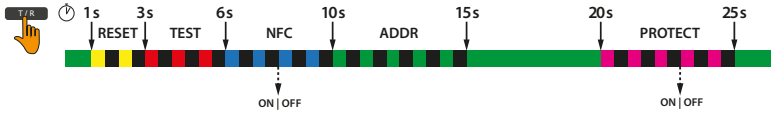

### "RESET" function

The "RESET" function on the button resets stored alarm states.

### "TEST" function

The "TEST" function simulates a residual current of  $1.5 \times I_{\Delta n}$  for a period of 5 seconds. During this period, the device has the following states:

- Display of the alarm value via the LEDs and the interface.
- The test status can be read out via the interface:
  - 0 = no test
  - 1 = internal test
  - 2 = external test (interface)
- For the duration of the test  $t_{on}$  and  $t_{off}$  are set to 0 s.

### "NFC" function

The "NFC" function changes the current activation status of the NFC interface, when the T/R button is pressed and held for a period of 6...10 s. The NFC interface disables automatically within 5 minutes, in case it has not been disabled manually before.

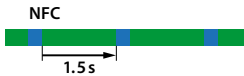

Status indication of normal operation with the NFC interface activated

### "ADDR" function

The "ADDR" function switches the device to address setting mode for the RS-485 address. The channel indication LEDs and the status LED indicate the device's address.

How to enter an address:

1. Press and hold the T/R button until status LED flashes green (10...15 s).
  - After the T/R button is released, the status LED lights red.
2. Set HUNDREDS digit. Press T/R button briefly until the desired value appears. Press and hold T/R button once (> 2 s) to confirm.
  - After the T/R button is released, the status LED lights green.
3. Set TENS digit. Press T/R button briefly until the desired value appears. Press and hold T/R button once (> 2 s) to confirm.
  - After the T/R button is released, the status LED lights blue.

4. Set UNITS digit. Press T/R button briefly until the desired value appears. Press and hold T/R button once (> 2 s) to confirm.
5. To exit the address setting mode, press and hold T/R button once (2 s).
  - After the T/R button is released, the status LED lights green.

The address values are displayed via BCD code.

Addresses can only be entered within the valid address range. When there is no input for a period of 5 minutes, the device automatically exits the address setting mode. The device then uses the currently set Modbus address.

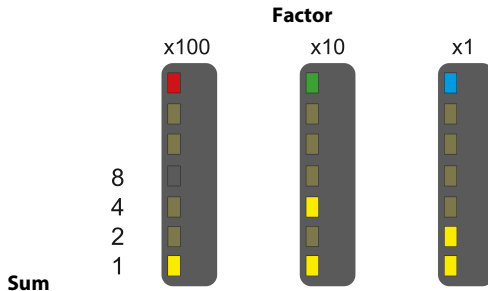

Current address: 153

### "PROTECT" function

The "PROTECT" function on the T/R button locks or enables write access to the Modbus registers of the individual parameters. Modbus register 32007 "Write access" can only lock write access but cannot enable it.

- When the T/R button is activated for at least 20 seconds, the status LED changes from continuously green to flashing violet and remains like this for the next 5 seconds when the button continues to be pressed.
- When the T/R button is released while the status LED is flashing violet, the activation state of the Modbus register " Write access" switches from the current selection of the two possible states to the other state, i. e. from "enabled" to "locked" or vice versa.

## 7 Modbus interface

### Overview

The following Modbus function codes are supported:

- Holding registers for reading out values (Read Holding Register; function code 0x03)
- Registers for device programming (Write Multiple Registers; function code 0x10)

For a complete Modbus-protocol specification, visit <http://www.modbus.org>.

### Read and write permissions

RO	Read Only (read access only)
RW	Read/Write (read and write access)
WO	Write Only (write access only)

### Data types

Float	IEEE754 32-Bit (single precision floating point number)	4 bytes
INT16	Signed 16-Bit Integer	2 bytes
INT32	Signed 32-Bit Integer	4 bytes
UINT8	Unsigned 8-Bit Integer	1 byte (shown as 2 bytes)
UINT16	Unsigned 16-Bit Integer	2 bytes
UINT32	Unsigned 32-Bit Integer	4 Bytes
String UTF8	ASCII character string	

### Register ranges

Range	Start address	End address
Info	0	998
Alarm and measuring values	999	1999
Monitoring functions	2000	2999
Status informationen	3000	3999
Harmonic analysis	5000	5699
Modbus RTU parameters	32000	32099
Input "I"	32300	32399
Input/output "Q"	32400	32499
Output "M+"	32500	32599
Response values	32600	32699
Function/response behaviour	32700	32799
Alarm behaviour	32800	32899

Range	Start address	End address
Time response	32900	32999
Monitoring functions	33000	33010
Measuring-current transformer	33100	33110
Device error codes	5800	58999
Control commands	59000	59010
Function-control commands	60000	60003

## 7.1 Device-information registers

### Device information (registers 0...998)

Register	Description	Format	Bytes	Prop-erty	Value/Unit/Comment
0	Device name	String UTF8	32	RO	e.g.: RCMS410-24
16	Article number	String UTF8	32	RO	e.g.: B74604040
32	Serial number	String UTF8	32	RO	10 digits, e.g.: 2002123456
48	Manufacturer	String UTF8	32	RO	Bender GmbH & Co. KG
64	Application D number	UINT16	2	RO	631 = D631
65	Application version number	UINT16	2	RO	xxx = Vx.xx
66	Application build number	UINT16	2	RO	Build#
67	Boot loader D number	UINT16	2	RO	632 = D632
68	Bootloader version number	UINT16	2	RO	xxx = Vx.xx
69	Boot loader build number	UINT16	2	RO	Build#
70	Device status	UINT16	2	RO	Bit 0 (LSB): NFC with 0 = disabled, 1 = enabled Bit 1...15: 0 (reserved)
71	Device characteristics	UINT16	2	RO	Bit 0 (LSB): Alarm-indicator relays CH1 and CH2 available Bit 1: Harmonic analysis available Bit 2: CT "type B/type B+" can be used Bit 3: External transformer ("Type A" only) can be used Bit 4: History memory can be used Bit 5...15: 0 (reserved) with 0 = no, 1 = yes

## 7.2 Alarm/measuring value registers

### Measured values (registers 999...1999)

Register	Description	Format	Bytes	Property	Values / Unit / Comment	
999	Number of active messages	UINT16	2	RO	0...n = number of active messages (device error, alarms, connection faults, ...) n is the number of messages that could also be attributed to an output (e. g. relay)	
1000	Residual current measured value, max.	AC CH1	UINT8	8	RO	Measured-value block: In each case the max. measured value incl. corresponding alarm and measuring-range states since the last Modbus query is output. Size of the measured-value block: 4 x UINT8 = 8 bytes Content of the measured-value block <ul style="list-style-type: none"> <li>Adr. Offset 0 (e.g. 1000): measured value, part 1 [Float32_t]</li> <li>Adr. Offset 1 (e.g. 1001): measured value, part 2 [Float32_t]</li> <li>Adr. Offset 2 (e.g. 1002): alarm status               <ul style="list-style-type: none"> <li>0: no alarm</li> <li>1: prewarning</li> <li>2: main alarm</li> </ul> </li> <li>Adr. Offset 3 (e.g. 1003): measuring range               <ul style="list-style-type: none"> <li>0: "="</li> <li>1: "&lt;"</li> <li>2: "&gt;"</li> </ul> </li> </ul>
1004		AC CH2	UINT8	8	RO	
1008		AC CH3	UINT8	8	RO	
1012		AC CH4	UINT8	8	RO	
1016		DC CH1	UINT8	8	RO	
1020		DC CH2	UINT8	8	RO	
1024		DC CH3	UINT8	8	RO	
1028		DC CH4	UINT8	8	RO	
1032		RMS CH1	UINT8	8	RO	
1036		RMS CH2	UINT8	8	RO	
1040		RMS CH3	UINT8	8	RO	
1044		RMS CH4	UINT8	8	RO	
1048		Current value of residual current	AC CH1	Float	4	
1050	AC CH2		Float	4	RO	
1052	AC CH3		Float	4	RO	
1054	AC CH4		Float	4	RO	
1056	DC CH1		Float	4	RO	
1058	DC CH2		Float	4	RO	
1060	DC CH3		Float	4	RO	
1062	DC CH4		Float	4	RO	
1064	RMS CH1		Float	4	RO	
1066	RMS CH2		Float	4	RO	
1068	RMS CH3		Float	4	RO	
1070	RMS CH4		Float	4	RO	

Register	Description	Format	Bytes	Property	Values / Unit / Comment	
1072	Residual current measured value, min.	AC CH1	Float	4	RO	Smallest measured value since the last Modbus query
1074		AC CH2	Float	4	RO	
1076		AC CH3	Float	4	RO	
1078		AC CH4	Float	4	RO	
1080		DC CH1	Float	4	RO	
1082		DC CH2	Float	4	RO	
1084		DC CH3	Float	4	RO	
1086		DC CH4	Float	4	RO	
1088		RMS CH1	Float	4	RO	
1090		RMS CH2	Float	4	RO	
1092		RMS CH3	Float	4	RO	
1094		RMS CH4	Float	4	RO	
1096		Residual current average	AC CH1	Float	4	
1098	AC CH2		Float	4	RO	
1100	AC CH3		Float	4	RO	
1102	AC CH4		Float	4	RO	
1104	DC CH1		Float	4	RO	
1106	DC CH2		Float	4	RO	
1108	DC CH3		Float	4	RO	
1110	DC CH4		Float	4	RO	
1112	RMS CH1		Float	4	RO	
1114	RMS CH2		Float	4	RO	
1116	RMS CH3		Float	4	RO	
1118	RMS CH4		Float	4	RO	

### 7.3 Register monitoring functions

#### Status monitoring functions (registers 2000...2050)

Register	Description	Format	Bytes	Property	Values / Unit / Comment
2000	CT status CT1	UINT16	2	RO	0 = OK 1 = short circuit 2 = interruption
2001	CT status CT2	UINT16	2	RO	
2002	CT status CT3	UINT16	2	RO	
2003	CT status CT4	UINT16	2	RO	

Register	Description	Format	Bytes	Property	Values / Unit / Comment
2014	Status Reload memory Input/output "Q"	UINT16	2	RO	0 = Reload memory inactive 1 = Reload memory active
2015	Status Reload memory Output "M+"	UINT16	2	RO	

## 7.4 Status information registers

### Status information (registers 3000...3999)

Register	Description	Format	Bytes	Property	Values/Unit/Comment
3000	Test status	UINT16	2	RO	0 = no active test 1 = test active via T/R button 2 = test active via interface
3001	Status of input "I"	UINT16	2	RO	0 = input is not operated 1 = input is operated
3002	Status of input/output "Q"	UINT16	2	RO	0 = input is not operated 1 = input is operated 2 = input/output "Q" is configured as output
3005	Status of output "Q"	UINT16	2	RO	Current status of the output: 0 = output inactive (no event of the message assignments occurred) 1 = output active (at least one event of the message assignments occurred)
3006	Status of output "M+"	UINT16	2	RO	
3009	Status of storage active input/output "Q"	UINT16	2	RO	The last active state (1) of the output is maintained until the next Modbus query.
3010	Status of memory active output "M+"	UINT16	2	RO	
3013	Memory status disabled input/output "Q"	UINT16	2	RO	The last inactive state (0) of the output is maintained until the next Modbus query.
3014	Memory status disabled output "M+"	UINT16	2	RO	

## 7.5 Harmonic-analysis registers

The registers (5000...5602) are only available with the optional function module A "Harmonic analysis". Otherwise these registers are reserved.



*With ordering number B84604042 the harmonic analysis is already enabled as a default.*



**Harmonic analysis, individual values H1...20**

Register	Description	Format	Bytes	Property	Values / Unit / Comment
<b>Measuring channel 1</b>					
5000	DC, CH1	UINT16	2	RO	Amount DC component channel 1 [mA]
5001	H1, CH1	UINT16	2	RO	1st harmonic [mA]
5002	H2, CH1	UINT16	2	RO	2nd harmonic [mA]
5003	H3, CH1	UINT16	2	RO	3rd harmonic [mA]
5004	H4, CH1	UINT16	2	RO	4th harmonic [mA]
5005	H5, CH1	UINT16	2	RO	5th harmonic [mA]
5006	H6, CH1	UINT16	2	RO	6th harmonic [mA]
5007	H7, CH1	UINT16	2	RO	7th harmonic [mA]
5008	H8, CH1	UINT16	2	RO	8th harmonic [mA]
5009	H9, CH1	UINT16	2	RO	9th harmonic [mA]
5010	H10, CH1	UINT16	2	RO	10th harmonic [mA]
5011	H11, CH1	UINT16	2	RO	11st harmonic [mA]
5012	H12, CH1	UINT16	2	RO	12nd harmonic [mA]
5013	H13, CH1	UINT16	2	RO	13rd harmonic [mA]
5014	H14, CH1	UINT16	2	RO	14th harmonic [mA]
5015	H15, CH1	UINT16	2	RO	15th harmonic [mA]
5016	H16, CH1	UINT16	2	RO	16th harmonic [mA]
5017	H17, CH1	UINT16	2	RO	17th harmonic [mA]
5018	H18, CH1	UINT16	2	RO	18th harmonic [mA]
5019	H19, CH1	UINT16	2	RO	19th harmonic [mA]
5020	H20, CH1	UINT16	2	RO	20th harmonic [mA]

Register	Description	Format	Bytes	Property	Values / Unit / Comment
<b>Measuring channel 2</b>					
5021	DC, CH2	UINT16	2	RO	Amount DC component channel 2 [mA]
5022	H1, CH2	UINT16	2	RO	1st harmonic [mA]
5023	H2, CH2	UINT16	2	RO	2nd harmonic [mA]
5024	H3, CH2	UINT16	2	RO	3rd harmonic [mA]
5025	H4, CH2	UINT16	2	RO	4th harmonic [mA]
5026	H5, CH2	UINT16	2	RO	5th harmonic [mA]
5027	H6, CH2	UINT16	2	RO	6th harmonic [mA]
5028	H7, CH2	UINT16	2	RO	7th harmonic [mA]

Register	Description	Format	Bytes	Property	Values / Unit / Comment
<b>Measuring channel 2</b>					
5029	H8, CH2	UINT16	2	RO	8th harmonic [mA]
5030	H9, CH2	UINT16	2	RO	9th harmonic [mA]
5031	H10, CH2	UINT16	2	RO	10th harmonic [mA]
5032	H11, CH2	UINT16	2	RO	11st harmonic [mA]
5033	H12, CH2	UINT16	2	RO	12nd harmonic [mA]
5034	H13, CH2	UINT16	2	RO	13rd harmonic [mA]
5035	H14, CH2	UINT16	2	RO	14th harmonic [mA]
5036	H15, CH2	UINT16	2	RO	15th harmonic [mA]
5037	H16, CH2	UINT16	2	RO	16th harmonic [mA]
5038	H17, CH2	UINT16	2	RO	17th harmonic [mA]
5039	H18, CH2	UINT16	2	RO	18th harmonic [mA]
5040	H19, CH2	UINT16	2	RO	19th harmonic [mA]
5041	H20, CH2	UINT16	2	RO	20th harmonic [mA]

Register	Description	Format	Bytes	Property	Values / Unit / Comment
<b>Measuring channel 3</b>					
5042	DC, CH3	UINT16	2	RO	Amount DC component channel 3 [mA]
5043	H1, CH3	UINT16	2	RO	1st harmonic [mA]
5044	H2, CH3	UINT16	2	RO	2nd harmonic [mA]
5045	H3, CH3	UINT16	2	RO	3rd harmonic [mA]
5046	H4, CH3	UINT16	2	RO	4th harmonic [mA]
5047	H5, CH3	UINT16	2	RO	5th harmonic [mA]
5048	H6, CH3	UINT16	2	RO	6th harmonic [mA]
5049	H7, CH3	UINT16	2	RO	7th harmonic [mA]
5050	H8, CH3	UINT16	2	RO	8th harmonic [mA]
5051	H9, CH3	UINT16	2	RO	9th harmonic [mA]
5052	H10, CH3	UINT16	2	RO	10th harmonic [mA]
5053	H11, CH3	UINT16	2	RO	11st harmonic [mA]
5054	H12, CH3	UINT16	2	RO	12nd harmonic [mA]
5055	H13, CH3	UINT16	2	RO	13rd harmonic [mA]
5056	H14, CH3	UINT16	2	RO	14th harmonic [mA]
5057	H15, CH3	UINT16	2	RO	15th harmonic [mA]
5058	H16, CH3	UINT16	2	RO	16th harmonic [mA]

Register	Description	Format	Bytes	Prop-erty	Values / Unit / Comment
<b>Measuring channel 3</b>					
5059	H17, CH3	UINT16	2	RO	17th harmonic [mA]
5060	H18 CH3	UINT16	2	RO	18th harmonic [mA]
5061	H19, CH3	UINT16	2	RO	19th harmonic [mA]
5062	H20, CH3	UINT16	2	RO	20th harmonic [mA]

Register	Description	Format	Bytes	Prop-erty	Values / Unit / Comment
<b>Measuring channel 4</b>					
5063	DC, CH4	UINT16	2	RO	Amount DC component channel 4 [mA]
5064	H1, CH4	UINT16	2	RO	1st harmonic [mA]
5065	H2, CH4	UINT16	2	RO	2nd harmonic [mA]
5066	H3, CH4	UINT16	2	RO	3rd harmonic [mA]
5067	H4, CH4	UINT16	2	RO	4th harmonic [mA]
5068	H5, CH4	UINT16	2	RO	5th harmonic [mA]
5069	H6, CH4	UINT16	2	RO	6th harmonic [mA]
5070	H7, CH4	UINT16	2	RO	7th harmonic [mA]
5071	H8, CH4	UINT16	2	RO	8th harmonic [mA]
5072	H9, CH4	UINT16	2	RO	9th harmonic [mA]
5073	H10, CH4	UINT16	2	RO	10th harmonic [mA]
5074	H11, CH4	UINT16	2	RO	11st harmonic [mA]
5075	H12, CH4	UINT16	2	RO	12nd harmonic [mA]
5076	H13, CH4	UINT16	2	RO	13rd harmonic [mA]
5077	H14, CH4	UINT16	2	RO	14th harmonic [mA]
5078	H15, CH4	UINT16	2	RO	15th harmonic [mA]
5079	H16, CH4	UINT16	2	RO	16th harmonic [mA]
5080	H17, CH4	UINT16	2	RO	17th harmonic [mA]
5081	H18 CH4	UINT16	2	RO	18th harmonic [mA]
5082	H19, CH4	UINT16	2	RO	19th harmonic [mA]
5083	H20, CH4	UINT16	2	RO	20th harmonic [mA]

Register	Description	Format	Bytes	Property	Values / Unit / Comment
<b>THD (Total Harmonic Distortion)</b>					
5084	THD CH1	UINT16	2	RO	THD channel 1
5085	THD validity CH1	UINT16	2	RO	Validity of the THD value 0: = 2: >
5086	THD CH2	UINT16	2	RO	THD channel 2
5087	THD validity CH2	UINT16	2	RO	Validity of the THD value 0: = 2: >
5088	THD CH3	UINT16	2	RO	THD channel 3
5089	THD validity CH3	UINT16	2	RO	Validity of the THD value 0: = 2: >
5090	THD CH4	UINT16	2	RO	THD channel 4
5091	THD validity CH4	UINT16	2	RO	Validity of the THD value 0: = 2: >

THD: Square root of the sum of the squares of the harmonics H1...20 (excluding fundamental) divided by the fundamental;  
range of values 0...10,000 [%]

### Full spectrum harmonic analysis (H1...400) for selectable channel

Register	Description	Format	Bytes	Property	Values / Unit / Comment
<b>Full spectrum (H1...H400)</b>					
5100	Request calculation of full spectrum	UINT16	2	RW	1 = channel 1 2 = channel 2 3 = channel 3 4 = channel 4
5101	Status of the full spectrum calculation	UINT16	2	RO	0 = calculation is still running or no calculation has been requested 1 = calculation completed
5102... 5199	Reserved				
5200	Full spectrum DC	UINT16	2	RO	Amount of DC component [mA]
5201	H1	UINT16	2	RO	1st harmonic [mA] of the selected channel
5202	H2	UINT16	2	RO	2nd harmonic [mA] of the selected channel
5203... 5600	H3...H400	UINT16		RO	3rd ... 400th harmonics [mA] of the selected channel

Register	Description	Format	Bytes	Property	Values / Unit / Comment
<b>Full spectrum (H1...H400)</b>					
5601	Full spectrum THD	UINT16	2	RO	THD: Square root of the sum of the squares of the harmonics H1...400 (excluding fundamental) divided by the fundamental; range of values 0...10,000 [%]
5602	THD validity full spectrum	UINT16	2	RO	Validity of the THD value 0: = 2: >

## 7.6 Modbus-parameter registers

### Modbus RTU parameters (registers 32000...32010)

Register	Description	Format	Bytes	Property	Value/Unit/Comment	Factory setting
32000	Device address	UINT16	2	RW	1...247	Last 2 digits of the serial number + 100
32001	Baud rate	UINT32	4	RW	9600, 19200, 38400, 57600, 115200	19200
32003	Parity	UINT16	2	RW	1 = even 2 = odd 3 = none	1
32004	Stop bits	UINT16	2	RW	1 = 1 2 = 2 3 = automatic	3
32005	Reserviert					
32006	Allow update	UINT16	2	RW	0 = do not allow SW-update via Modbus RTU 1 = allow SW-update via Modbus RTU	0
32007	Write access	UINT16	2	RW	1: Enable write access (parameters can be changed) 2: Write access disabled (parameters can only be read)  <b>i</b> <i>Achtung: Entsperrn ist nur direkt am Gerät möglich!</i>	1

## 7.7 Registers of digital input "I"

### Parameters of input "I" (32300)

Register	Description	Format	Bytes	Property	Values/Unit/Comment	Factory setting
32300	Mode	UINT16	2	RW	1 = high-active 2 = low-active	2
32301	Function	UINT16	2	RW	1 = none 2 = reset 3 = test 4 = T/R (test/reset combined)	3

## 7.8 Registers of input/output "Q"

### Parameters of input/ output "Q" (32400)

Register	Description	Format	Bytes	Property	Value/Unit/Comment	Factory setting
32400	Mode	UINT16	2	RW	1 = output: passive 2 = output: high-active 3 = output: low-active 4 = output: permanently high 5 = output: permanently low 6 = input: high-active 7 = input: low-active	3
32401	Function	UINT16	2	RW	0 = none Available with modes 6...7: 1 = reset 2 = test Available with modes 1...3: 3 = prewarning 4 = main alarm	4
32402	Test	UINT16	2	RW	0 = disabled 1 = enabled	1
32403	Device-error alarm assignment	UINT16	2	RW	0 = disabled 1 = enabled	1
32404	AC CT1 alarm assignment	UINT16	2	RW	0 = disabled 1 = enabled	0
32405	AC CT2 alarm assignment	UINT16	2	RW		0
32406	AC CT3 alarm assignment	UINT16	2	RW		0
32407	AC CT4 alarm assignment	UINT16	2	RW		0
32408	DC CT1 alarm assignment	UINT16	2	RW	0 = disabled 1 = enabled	0
32409	DC CT2 alarm assignment	UINT16	2	RW		0
32410	DC CT3 alarm assignment	UINT16	2	RW		0
32411	DC CT4 alarm assignment	UINT16	2	RW		0
32412	RMS CT1 alarm assignment	UINT16	2	RW	0 = disabled 1 = enabled	1
32413	RMS CT2 alarm assignment	UINT16	2	RW		1
32414	RMS CT3 alarm assignment	UINT16	2	RW		1
32415	RMS CT4 alarm assignment	UINT16	2	RW		1

Register	Description	Format	Bytes	Property	Value/Unit/Comment	Factory setting
32416	CT Connection-fault alarm assignment CT1...4	UINT16	2	RW	0 = disabled 1 = enabled	1
32417	Measuring-channels-overloading alarm assignment	UINT16	2	RW	0 = disabled 1 = enabled	1
32418	Reload cycles	UINT16	2	RW	0...10 = Number of switching cycles until the output status is frozen	0
32419	Reload time	UINT16	2	RW	2...60 [s] = time until reload counter will be reset	6

## 7.9 Registers of output "M+"

### Parameters of output "M+" (registers 32500...32530)

Register	Description	Format	Bytes	Property	Values / Unit / Comment	Factory setting
32500	Mode	UINT16	2	RW	1 = output: passive 2 = output: high-active 3 = output: low-active 4 = output: permanently high 5 = output: permanently low 6 = output: 0...20 mA 7 = output: 4...20 mA 8 = output: 0...10 V 9 = output: 2...10 V	3
32501	Function	UINT16	2	RW	0 = none Operative with mode 1...3: 1 = prewarning 2 = main alarm Operative with mode 6...9: 3 = channel 1 (RMS) 4 = channel 2 (RMS) 5 = channel 3 (RMS) 6 = channel 4 (RMS)	2
32502	Linearity	UINT16	2	RW	Operative with function 3...6: 1 = linear with respect to maximum scale value (see register 32503) 2 = linear with respect to 100 % of $I_{\Delta n \text{ RMS}}$	2
32503	Scaling	UINT16	2	RW	Operative only with linearity 1: 0...65000 [mA], increment 1 mA, maximum scale value  <b>i</b> Note: This value can be set to max. $5 \times I_{\Delta n \text{ RMS}}$	0
32504	Test	UINT16	2	RW	0 = disabled 1 = enabled	1
32505	Device-error alarm assignment	UINT16	2	RW	0 = disabled 1 = enabled	1

Register	Description	Format	Bytes	Property	Values / Unit / Comment	Factory setting
32506	AC CT1 alarm assignment	UINT16	2	RW	0 = disabled 1 = enabled	0
32507	AC CT2 alarm assignment	UINT16	2	RW		0
32508	AC CT3 alarm assignment	UINT16	2	RW		0
32509	AC CT4 alarm assignment	UINT16	2	RW		0
32510	DC CT1 alarm assignment	UINT16	2	RW	0 = disabled 1 = enabled	0
32511	DC CT2 alarm assignment	UINT16	2	RW		0
32512	DC CT3 alarm assignment	UINT16	2	RW		0
32513	DC CT4 alarm assignment	UINT16	2	RW		0
32514	RMS CT1 alarm assignment	UINT16	2	RW	0 = disabled 1 = enabled	1
32515	RMS CT2 alarm assignment	UINT16	2	RW		1
32516	RMS CT3 alarm assignment	UINT16	2	RW		1
32517	RMS CT4 alarm assignment	UINT16	2	RW		1
32518	Alarm assignment, CT-connection fault	UINT16	2	RW	0 = disabled 1 = enabled	1
32519	Measuring-channels-overloading alarm assignment	UINT16	2	RW	0 = disabled 1 = enabled	1
32520	Reload cycles	UINT16	2	RW	0...10 = Number of switching cycles until the output status is frozen	0
32521	Reload time	UINT16	2	RW	2...60 [s] = time until reload counter will be reset	6



## 7.10 Registers of response-value parameters

### Response-value parameters (registers 32600...32635)

Register	Description	Format	Bytes	Property	Values / Unit / Comment	Factory setting
32600	Main alarm response value $I_{\Delta n}$ AC CT1	Float	4	RW	Enabled only with "type B"/"type B+" current transformers 0.010...10 [A] increment 0.001  <i>When "type B/type B+" current transformers are used: If no separate AC and DC response values are set, the response values shall be set to the same value as the RMS response value (reg. 32616...32622).</i>	0.03
32602	$I_{\Delta n}$ AC CT2	Float	4	RW		0.03
32604	$I_{\Delta n}$ AC CT3	Float	4	RW		0.03
32606	$I_{\Delta n}$ AC CT4	Float	4	RW		0.03
32608	$I_{\Delta n}$ DC CT1	Float	4	RW		0.03
32610	$I_{\Delta n}$ DC CT2	Float	4	RW		0.03
32612	$I_{\Delta n}$ DC CT3	Float	4	RW		0.03
32614	$I_{\Delta n}$ DC CT4	Float	4	RW		0.03
32616	$I_{\Delta n}$ RMS CT1	Float	4	RW		For "type A" current transformers: 0.006...30 [A]; increment 0.001; For "type B/type B+" current transformers: 0.010...10 [A] increment 0.001
32618	$I_{\Delta n}$ RMS CT2	Float	4	RW	0.03	
32620	$I_{\Delta n}$ RMS CT3	Float	4	RW	0.03	
32622	$I_{\Delta n}$ RMS CT4	Float	4	RW	0.03	
32624	AC CT1 prewarning	UINT16	2	RW	With overcurrent mode: 10...100 [%]; increment 1 With undercurrent mode: 10...100 [%] (prewarning = register value + 100 = 110...200 [%]); increment 1 With window discriminator mode: 10...100 [%]; increment 1	70
32625	AC CT2 prewarning	UINT16	2	RW		70
32626	AC CT3 prewarning	UINT16	2	RW		70
32627	AC CT4 prewarning	UINT16	2	RW		70
32628	DC CT1 prewarning	UINT16	2	RW		70
32629	DC CT2 prewarning	UINT16	2	RW		70
32630	DC CT3 prewarning	UINT16	2	RW		70
32631	DC CT4 prewarning	UINT16	2	RW		70
32632	RMS CT1 prewarning	UINT16	2	RW		70
32633	RMS CT2 prewarning	UINT16	2	RW		70
32634	RMS CT3 prewarning	UINT16	2	RW		70
32635	RMS CT4 prewarning	UINT16	2	RW		70

## 7.11 Function and operating-characteristics registers

### Function and response behaviour parameters (32700...32720)

Register	Description	Format	Bytes	Property	Value/Unit/Comment	Factory setting		
32700	CT1 function	UINT16	2	RW	1 = overcurrent 2 = undercurrent 3 = window mode 4 = digital input: high-active 5 = digital input: low-active 6 = none	1		
32701	CT2 function	UINT16	2	RW				
32702	CT3 function	UINT16	2	RW				
32703	CT4 function	UINT16	2	RW				
32704	CT1 hysteresis	UINT16	2	RW				
32705	CT2 hysteresis	UINT16	2	RW				
32706	CT3 hysteresis	UINT16	2	RW	2...40 [%], increment 1 %	15		
32707	CT4 hysteresis	UINT16	2	RW				
32708	CT1 filter setting	UINT16	2	RW			1 = no Filter 2 = type A 3 = type F 4 = type B 5 = type B+ 6 = 50 Hz 7 = 60 Hz 8 = 150 Hz 9 = 180 Hz 10 = 500 Hz 11 = 1000 Hz 12 = 2000 Hz 13 = 5000 Hz 14 = 10000 Hz	1 (With factory enabled function module B: 4)
32709	CT2 filter setting	UINT16	2	RW				
32710	CT3 filter setting	UINT16	2	RW				
32711	CT4 filter setting	UINT16	2	RW				
32712	Fundamental-harmonic frequency	UINT16	2	RW	50...1000 Hz; increment 1 Hz	50		
32713	Preset factor	UINT16	2	RW	1...99; increment 1	3		
32714	Preset offset	UINT16	2	RW	0...30000; increment 1 [mA]	30		
32715	Automatic measuring range switching of CT1	UINT16	2	RW	0 = disabled 1 = enabled	0		
32716	Automatic measuring range switching of CT2	UINT16	2	RW				
32717	Automatic measuring range switching of CT3	UINT16	2	RW				
32718	Automatic measuring range switching of CT4	UINT16	2	RW				

## 7.12 Alarm-behaviour registers

### Alarm behaviour parameters (32800...32810)

Register	Description	Format	Bytes	Property	Values / Unit / Comment	Factory setting
32800	CH1 fault memory	UINT16	2	RW	0 = disabled 1 = enabled	0
32801	CH2 fault memory	UINT16	2	RW		0
32802	CH3 fault memory	UINT16	2	RW		0
32803	CH4 fault memory	UINT16	2	RW		0
32804	CH1 starts in alarm status	UINT16	2	RW	0 = disabled 1 = enabled	0
32805	CH3 starts in alarm status	UINT16	2	RW		0
32806	CH3 starts in alarm status	UINT16	2	RW		0
32807	CH4 starts in alarm status	UINT16	2	RW		0

## 7.13 Time-behaviour registers

### Time behaviour parameters (32900...32920)

Register	Description	Format	Bytes	Property	Value/Unit/Comment	Factory setting
32900	Start-up delay	Float	4	RW	0...999 [s], increment 1 ms	0
32902	Response delay $t_{on}$ CH1	Float	4	RW	0...10 [s], increment 1 ms	0
32904	Response delay $t_{on}$ CH2	Float	4	RW		0
32906	Response delay $t_{on}$ CH3	Float	4	RW		0
32908	Response delay $t_{on}$ CH4	Float	4	RW		0
32910	Delay on release $t_{off}$ CH1	Float	4	RW	0...999 [s], increment 1 ms	1
32912	Delay on release $t_{off}$ CH2	Float	4	RW		1
32914	Delay on release $t_{off}$ CH3	Float	4	RW		1
32916	Delay on release $t_{off}$ CH4	Float	4	RW		1

## 7.14 Monitoring-functions registers

### Parameters CT-connection monitoring (33000)

Register	Description	Format	Bytes	Property	Value/Unit/Comment	Factory setting
33000	CT-connection monitoring, CT1	UINT16	2	RO	0 = disabled 1 = enabled	1
33001	CT-connection monitoring, CT2	UINT16	2	RO		1
33002	CT-connection monitoring, CT3	UINT16	2	RO		1
33003	CT-connection monitoring, CT4	UINT16	2	RO		1

## 7.15 Measuring-current-transformer registers

### CT-parameters (33100)

Register	Description	Format	Bytes	Property	Values / Unit / Comment	Factory setting
33100	Type of measuring-current transformer, CT1	UINT16	2	RW	1 = "type A" 2 = "type B"	1 (With factory enabled function module B: 2)
33101	Type of measuring-current transformer, CT2	UINT16	2	RW		
33102	Type of measuring-current transformer, CT3	UINT16	2	RW		
33103	Type of measuring-current transformer, CT4	UINT16	2	RW		
33104	Number of windings, CT1	UINT16	2	RW	 These registers can only be used, when the function module C "external current transformer connection" is enabled. If not, they are reserved. When an external current transformer is used, it is imperative that a turn number be selected.	600
33105	Number of windings, CT2	UINT16	2	RW		600
33106	Number of windings, CT3	UINT16	2	RW		600
33107	Number of windings, CT4	UINT16	2	RW		600

## 7.16 Device-error-code registers

### Device error codes (58000)



Register content 0 = no error

Undocumented registers 58000...58199 are reserved.

Register	Description	Format	Bytes	Property	Value/Unit/Comment	Reversible	Device faulty
58000	Number of device errors	UINT16	2	RO	Number of active device errors	X	
58001	0.10	UINT16	2	RO	10 = CT-connection fault, CT1	X	
58002	0.11	UINT16	2	RO	11 = CT-connection fault, CT2	X	
58003	0.12	UINT16	2	RO	12 = CT-connection fault, CT3	X	
58004	0.13	UINT16	2	RO	13 = CT-connection fault, CT4	X	
58005	0.57	UINT16	2	RO	57 = connection fault at input/output "Q"	X	
58006	0.58	UINT16	2	RO	58 = connection fault at output "M+"	X	
58007	3.21	UINT16	2	RO	321 = internal error		X
58008	3.25	UINT16	2	RO	325 = internal error		X
58009	4.70	UINT16	2	RO	470 = thermal overload at measuring inputs	X	
58010	4.71	UINT16	2	RO	471 = CT1 overload	X	
58011	4.72	UINT16	2	RO	472 = CT2 overload	X	
58012	4.73	UINT16	2	RO	473 = CT3 overload	X	
58013	4.74	UINT16	2	RO	474 = CT4 overload	X	
58014	4.75	UINT16	2	RO	475 = invalid setting of CT1: AC, DC and/or RMS response values are too far apart	X	
58015	4.76	UINT16	2	RO	476 = invalid setting of CT2: AC, DC and/or RMS response values are too far apart	X	
58016	4.77	UINT16	2	RO	477 = invalid setting of CT3: AC, DC and/or RMS response values are too far apart	X	
58017	4.78	UINT16	2	RO	478 = invalid setting of CT4: AC, DC and/or RMS response values are too far apart	X	
58018	4.79	UINT16	2	RO	479 = invalid setting of CT1: "type B+" filter combined with a response value > 300 mA	X	
58019	4.80	UINT16	2	RO	480 = invalid setting of CT2: "type B+" filter combined with a response value > 300 mA	X	

Register	Description	Format	Bytes	Property	Value/Unit/Comment	Reversible	Device faulty
58020	4.81	UINT16	2	RO	481 = invalid setting of CT3: "type B+" filter combined with a response value > 300 mA	X	
58021	4.82	UINT16	2	RO	482 = invalid setting of CT4: "type B+" filter combined with a response value > 300 mA	X	
58022	4.83	UINT16	2	RO	483 = invalid setting of CT1: AC response value < 10 mA or > 10 A with a "type B" measuring-current transformer	X	
58023	4.84	UINT16	2	RO	484 = invalid setting of CT2: AC response value < 10 mA or > 10 A with a "type B" measuring-current transformer	X	
58024	4.85	UINT16	2	RO	485 = invalid setting of CT3: AC response value < 10 mA or > 10 A with a "type B" measuring-current transformer	X	
58025	4.86	UINT16	2	RO	486 = invalid setting of CT4: AC response value < 10 mA or > 10 A with a "type B" measuring-current transformer	X	
58026	6.00	UINT16	2	RO	600 = internal error		X
58027	6.10	UINT16	2	RO	610 = internal error		X
58028	6.31	UINT16	2	RO	631 = internal error		X
58029	6.51	UINT16	2	RO	651 = internal error		X
58030	7.61	UINT16	2	RO	761 = internal error		X
58031	7.62	UINT16	2	RO	762 = internal error		X
58032	7.63	UINT16	2	RO	763 = internal error		X
58033	8.20	UINT16	2	RO	820 = internal error		X
58034	8.24	UINT16	2	RO	824 = T/R button defective	X	
58035	8.43	UINT16	2	RO	843 = internal error		X
58036	8.44	UINT16	2	RO	844 = internal error		X
58037	8.45	UINT16	2	RO	845 = internal error		X
58038	8.46	UINT16	2	RO	846 = internal error		X
58039	8.49	UINT16	2	RO	849 = internal error		X
58040	6.20	UINT16	2	RO	620 = Measured offset is outside the limits	X	
58041	7.64	UINT16	2	RO	764 = internal error		X
58042	6.95	UINT16	2	RO	695 = internal error		X
58043... 58099	Reserved						

Register	Description	Format	Bytes	Property	Value/Unit/Comment	Reversible	Device faulty
58100	3.21	UINT16	2	RO	321 = internal error		X
58101	3.22	UINT16	2	RO	322 = internal error		X
58102	3.23	UINT16	2	RO	323 = internal error		X
58103	3.24	UINT16	2	RO	324 = internal error		X
58104	3.26	UINT16	2	RO	326 = internal error		X
58105	3.27	UINT16	2	RO	327 = internal error		X
58106	6.30	UINT16	2	RO	630 = internal error		X
58107	7.64	UINT16	2	RO	764 = internal error		X

## 7.17 Control-commands registers

### Control commands (59000)

Register	Description	Format	Bytes	Property	Values / Unit / Comment	Factory setting
59000	NFC	UINT16	2	RW	0 = disabled 1 = enabled (automatic disabling after 5 min)	0
59003	Start PRESET function	UINT16	2	WO	1 = start PRESET	-
59004	Start DC-offset fine matching	UINT16	2	WO	1 = Start synchronisation CH1 2 = Start synchronisation CH2 3 = Start synchronisation CH3 4 = Start synchronisation CH4	-

## 7.18 Function-control-commands registers



Register 60000 (function-selection register) defines which function is enabled.  
Only specified values are permitted.

0 = Find device via serial number

1 = Set Modbus address

2 = Find device

4 = Reset to factory settings with/without interface parameters

6 = Start test

7 = Reset

8 = Upload licence key



**The registers 60000...60003 must always be written as a block!**

## Function-control commands (60000)

Register	Description	Format	Bytes	Property	Value/Unit/Comment
<b>Function 0: Find device via serial number</b>					
60000	Function selection	UINT16	2	WO	0 = selection of the function "Find device via serial number"
60001	Serial number	UINT32	4	WO	Seriennummer des zu findenden Geräts
60003	Period	UINT16	2	WO	0...300 [s] = time until the corresponding device lights up; 0 = end search function
<b>Function 1: Set Modbus address</b>					
60000	Function selection	UINT16	2	WO	1 = Selection of the function "Set Modbus address"
60001	Serial number	UINT32	4	WO	Serial number of the device to be given a new modbus address. Only the device with the corresponding serial number will accept the new Modbus address.
60003	Modbus address	UINT16	2	WO	0...247 = new Modbus address
<b>Function 2: Find device</b>					
60000	Function selection	UINT16	2	WO	2 = Selection of the "Find device" function
60001	Pattern value part 1	UINT16	2	WO	61918 Security pattern must be written for the function to be executed.
60002	Pattern value part 2	UINT16	2	WO	0 Security pattern must be written for the function to be executed.
60003	Period	UINT16	2	WO	0...300 [s] = time until the device lights up. When the device receives the value "0", the function is stopped.
<b>Function 4: Reset to factory settings with/without interface parameters</b>					
60000	Function selection	UINT16	2	WO	4 = Selection of the function "Reset to factory settings with/without interface parameters"
60001	Pattern value part 1	UINT16	2	WO	64199 Security pattern must be written for the function to be executed.
60002	Pattern value part 2	UINT16	2	WO	1304 Security pattern must be written for the function to be executed.
60003	Reset type	UINT16	2	WO	1 = Reset all parameters to the factory settings 2 = Reset to factory settings without interface parameters
<b>Function 6: Start test</b>					
60000	Function selection	UINT16	2	WO	6 = Selection of the function "Start test"
60001	Pattern value part 1	UINT16	2	WO	32343 Security pattern must be written for the function to be executed.
60002	Pattern value part 2	UINT16	2	WO	0 Security pattern must be written for the function to be executed.
60003	Type of test	UINT16	2	WO	3 = Start RCM test
<b>Function 7: Reset</b>					
60000	Function selection	UINT16	2	WO	7 = Selection of "Reset" function
60001	Pattern value part 1	UINT16	2	WO	13623 Security pattern must be written for the function to be executed.



Register	Description	Format	Bytes	Property	Value/Unit/Comment
60002	Pattern value part 2	UINT16	2	WO	0 Security pattern must be written for the function to be executed.
60003	Reset type	UINT16	2	WO	1 = Reset of the alarm message when fault memory is enabled
<b>Function 8: Upload licence key</b>					
60000	Function selection	UINT16	2	WO	8 = Selection of "Upload licence key" function
60001	Pattern value part 1	UINT16	2	WO	29134 Security pattern must be written for the function to be executed.
60002	Pattern value part 2	UINT16	2	WO	0 Security pattern must be written for the function to be executed.
60003	licence key	UINT8 []	32	WO	[...] = licence key as a byte array

## 8 Error – Cause – Error correction

Error pattern	Cause	Correction
<b>Complete device</b>		
No device start	Terminal blocks incorrectly plugged in	Plug in terminal blocks correctly.
	Supply voltage incorrectly connected	Establish correct wiring.
<b>RS-485</b>		
Instable communication	Missing termination due to incorrect commissioning or defective component. No device is terminated.	Configure the terminating resistor, determine the terminating resistor value and replace it if necessary.
	Faulty termination due to incorrect commissioning or defective component. Either only one or more than two devices have been terminated.	Configure the terminating resistor, check quality of the bus signal.
No communication	Incorrect configuration: different baud rates between bus devices.	Calibrate baud rates between all bus devices.
	Incorrect connection: terminals A and B are interchanged.	Establish correct bus wiring.
<b>Inputs and outputs</b>		
No level change	Incorrect configuration: Output configured as input	Check configuration.
	Incorrect connection: external connections	Check configuration.
<b>Alarm relays</b>		
Relays do not energise	No alarm message due to defective component or defective controlling devices. No alarm source has been assigned.	Check relay for proper function, replace device if necessary. Assign alarm sources.
Relays do not de-energise	No alarm reset due to sticking or defective relay. Switching current > 5 A.	Replace device, if necessary. Observe technical data of the switching output.
	No switching of the relay due to excessive preloads on contacts.	Observe technical data of the switching output.
<b>Enclosure</b>		
Broken screw-mounting brackets	Device becomes detached due to broken mounting brackets.	Preventive measure: Use correct screw type and observe max. tightening torque. If the screw-mounting brackets are defective: mount on DIN rail or replace device.
Non-compliance with the insulation guideline	Insufficient insulation due to insufficient distance between mounting screws and connecting wires.	Use screws with plastic cover or mount on DIN rail.
<b>Terminals</b>		
Wires detach from the terminal	Due to splicing of wire ends, it is not possible to insert them into the terminal or fix them firmly in the terminal.	Use ferrules for mounting and connection to flexible cables.
Wires cannot be removed from terminal	Ferrules with strong crimp impressions get stuck in the terminal.	Use correct crimping pliers for mounting and connection with flexible cables.

## 9 Technical data

### 9.1 Frequency responses of the filters

The curves represent the area in which the device triggers a main alarm.

**i** The frequency range below 15 Hz is not defined.

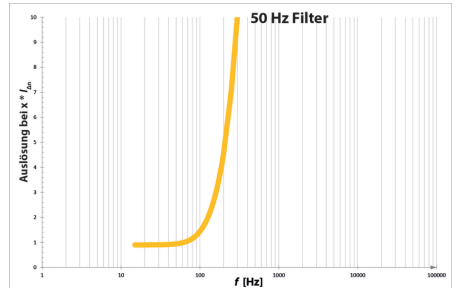
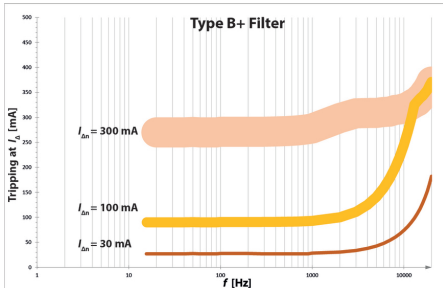
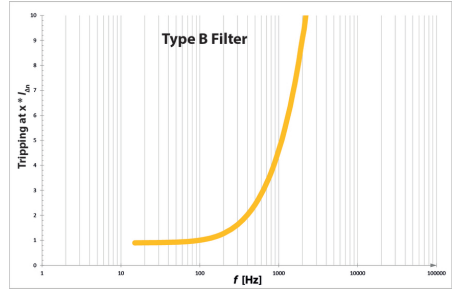
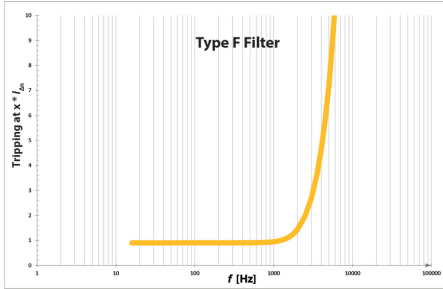
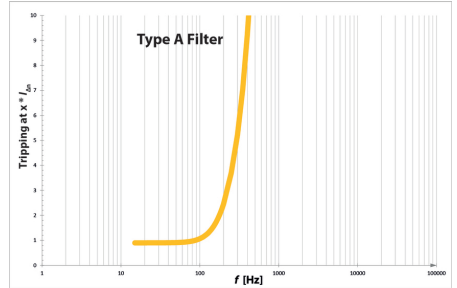
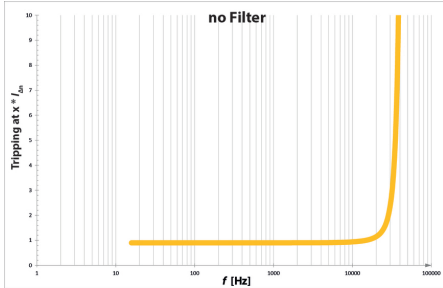

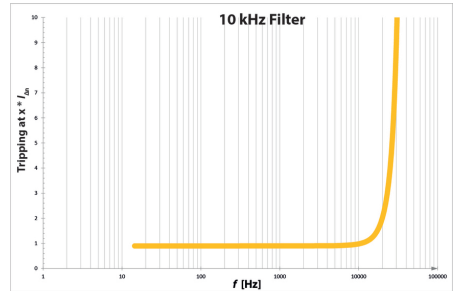
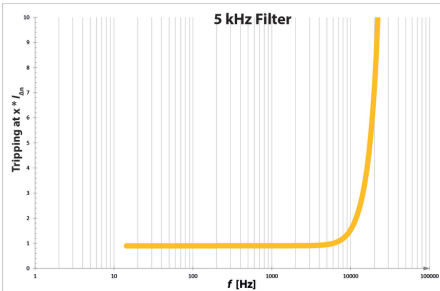
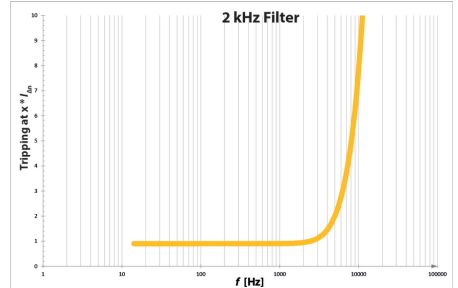
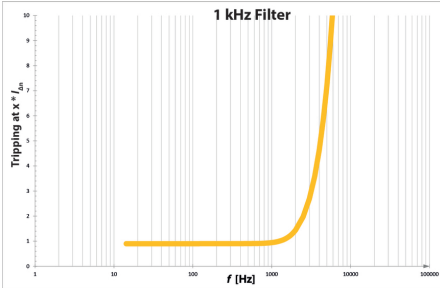
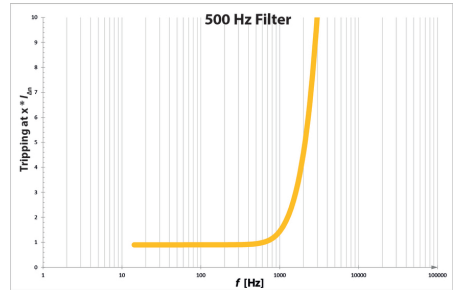
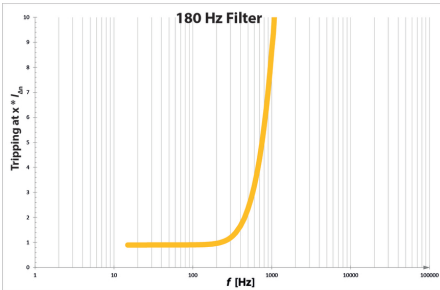
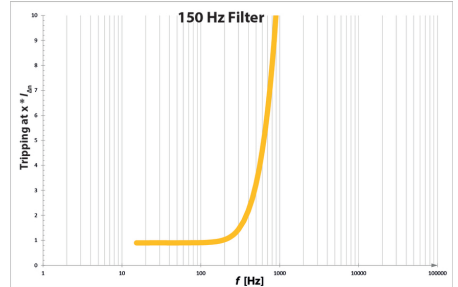
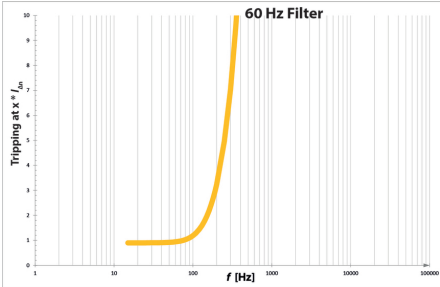

## 9.2 Tabular data

(<sup>o</sup>)\* = Factory setting

### Insulation coordination (IEC 60664-1/IEC 60664-3)

Rated voltage	50 V
Overvoltage category	III
Rated impulse voltage	800 V
Rated insulation voltage	50 V
Pollution degree	2

### Supply voltage (+, -)

Connection	+, -
Supply voltage $U_s$	DC 24 V
Protection class of power supply unit	2 or 3
Permissible tolerance	-30...+25 %
Permissible ripple	5 %
Power consumption	≤ 2 W
Inrush current (< 5 ms)	< 10 A

### Measuring circuit

Burden (internal)	33 Ω
Frequency range (for details see chapter "Frequency responses of the filters", page 59)	DC, 15 Hz...20 kHz
Measuring range (peak)	3 mA...100 A
Measuring range rms	2 mA...70 A
Rated residual operating current	
Type A, Type F	30 A
Type B, Type B+	10 A
Response value main alarm $I_{\Delta n}^{(1)}$	
Type A, Type F	6 mA...30 A (30 mA)*
Type B, Type B+	10 mA...10 A (30 mA)*
Prewarning	10...100 % x $I_{\Delta n}$ (50 %)*
Operating uncertainty	±10 % (at 0.5...5 x $I_{\Delta n}$ )
Relative response uncertainty	

Type A, Type F	6 mA...20 A: -20...0 % 20...30 A: -50...0 %
Type B, Type B+	-20...0 %
Hysteresis	10...25 % (15 %)*
Fault-memory alarm messages	on/off (on)*
Permissible continuous residual current with	
single-channel use	85 A
dual-channel use	60 A
use of three channels	49 A
use of four channels	42 A

1) The requirements of the respective standards are only met with a response value from 30 mA to 9.9 A.

### Measuring-current transformers

Connection	CT1...4 (S1, S2)
Measuring-current transformer series	
Type A	CTAC, CTAS, W, WR, WS
Type F	CTAC
Type B, Type B+	CTUB-CTBC, CTBS
CT connection monitoring	yes
Rated voltage $U_n$	see measuring-current-transformer manual
Connecting wires	see measuring-current-transformer manual
Cable length	
CT Type B	≤ 10 m
CT Type A (single wire $\geq 0.75 \text{ mm}^2$ )	≤ 10 m
CT Type A (shielded cable $\geq 0.75 \text{ mm}^2$ )	≤ 40m
For UL applications	60/75 °C copper conductors
External transformers	
Permissible continuous secondary current with	
Single-channel use	140 mA
Dual-channel use	100 mA
Use of three channels	80 mA
Use of four channels	70 mA
Permissible number of windings	100...2000

## Time response

Start-up delay $t$	0...999 s (0 s)*
Response delay $t_{on}$	0...10 s (0 s)*
Delay on release $t_{off}$	0...999 s (1 s)*
Operating time $t_{ae}$	
with $1 \times I_{\Delta n}$	$\leq 260$ ms
with $5 \times I_{\Delta n}$	40...100 ms
Response time $t_{an}$	$t_{an} = t_{ae} + t_{on}$
Recovery time $t_b$	$\leq 500$ ms
Response time for CT connection monitoring	$\leq 10$ s

## Operation

Display	status LED, alarm LEDs, channel LEDs
Button T/R	reset / test / NFC / address setting / protect
Terminating resistor DIP switches	on/off (off)*

## RS-485 interface

Connection	A, B
Protocol	Modbus RTU
Baud rate	Max. 115.2 kbits/s (19.2 kbits/s)*
Parity	even, no, odd (even)*
Stop bits	1/2/auto (auto)*
Cable length (at 9.6 kbits/s)	$\leq 1200$ m
Recommended lines, shield on one side connected to PE	
CAT6/CAT7	Min. AWG23
min. J-Y(St)Y 2 x 0.6 mm <sup>2</sup>	Twisted pair
Device address	1...247 (100 + last two digits of serial number)*

## NFC interface

Frequency	13.56 MHz
Transmitting power **	0 W

\*\* EMC influences may lead to communication interruptions at the NFC interface.

### Input I

Connection	I, $\perp$
Max. cable length (recommended)	10 m
External connections	Potential-free contact

### Input/output Q

Connection	Q, $\perp$
Max. cable length (recommended)	10 m
Max. load	20 mA
Low voltage level (output)	0...2 V
High voltage level (output)	10 V... $U_S$
External voltage (passive mode)	DC 0...( $U_S - 1$ V)

### Output M+

Connection	M+, $\perp$
Max. cable length (recommended)	10 m
Max. load	20 mA
Burden	
Current output	$\leq 600 \Omega$
Voltage output	$\geq 10 \text{ k}\Omega$
Tolerance with respect to final current/voltage value	$\pm 20 \%$
External voltage (passive mode)	DC 0... $U_S$

### Connections

Terminals	Plug-in screw-type terminals
Terminal series	Phoenix Contact MC 1,5/ -ST-3,5 BK
Connection properties	
Rigid	0.14...1.5 mm <sup>2</sup>
Flexible, without plastic sleeve	0.25...1.5 mm <sup>2</sup>
Flexible, with plastic sleeve	0.25...0.5 mm <sup>2</sup>
Stripping length	7 mm
Tightening torque	0.22...0.25 Nm
Conductor cross section AWG	28...16



**EMC/Environment**

EMC	DIN EN IEC 62020-1
Operating temperature	-40...+70 °C
Transport	-40...+85 °C
Long-time storage	-40...+70 °C

Classification of climatic conditions acc. to IEC 60721 (except condensation and formation of ice)

Stationary use (IEC 60721-3-3)	3K22
Transport (IEC 60721-3-2)	2K11
Long-term storage (IEC 60721-3-1)	1K22

Classification of mechanical conditions acc. to IEC 60721

Stationary use (IEC 60721-3-3)	3M11
Transport (IEC 60721-3-2)	2M4
Long-term storage (IEC 60721-3-1)	1M12

**Other**

Operating mode	Continuous operation
Mounting	Vertical
Degree of protection (DIN EN 60529)	
terminals	IP20
internal components	IP30
Enclosure material	Polycarbonate
DIN rail mounting acc. to	IEC 60715
Flammability class	UL94 V-0
Weight	≤ 55 g

**9.3 Approvals****Standards & certifications**

The RCMS410 device has been developed in accordance with the following standards:

- DIN EN IEC 62020-1

- UL508



## Licences

For a list of the open-source software used see our [Homepage](#).

## Declaration regarding the radio system

### EU declaration of conformity

Bender GmbH & Co. KG hereby declares that the device covered by the Radio Equipment Directive complies with Directive 2014/53/EU. The full text of the EU Declaration of Conformity is available at the following internet address:

[EU declaration of conformity](#)

## 9.4 Ordering information

Type	Supply voltage $U_S$	Measuring current transformers that can be used		Configurable at the factory	Enabled function modules *	Art. No.
		Type A Type F	Type B Type B+			
RCMS410-24	DC 24 V	X	(X) with function module B	In preparation	In preparation: Customised ex factory (A, B, C can be bought later)	B84604040
		X	X	-	B (A and C can be bought later)	B84604041
		X	X	-	A, B, C	B84604042

\* Function modules

A: Harmonic analysis (FFT)

B: AC/DC sensitive measuring and evaluation of values

C: Connection of type A external current transformers

Accessories	Art. No.
Sealable transparent cover	B80609199

## 9.5 Document revision history

Date	Document version	Valid from software version	Status/changes
09.2022	00		Initial edition
03.2023	01	D0631	Added Chapter "PROTECT function" Chapter "Document revision history" Editorial revision Chapter "'Functional description", page 10" Note in chapter "'Measuring-current-transformer connection"', page 19 Curves "'Frequency responses of the filters", page 59" Chapter "'Tabular data" Chapter "'Standards and certifications", page 65 Chapter "'Ordering information"
05.2023	02		Corrected Naming of the function modules in the document
05.2025	03	D0632	Editorial revision Entire document



**Bender GmbH & Co. KG**

Londorfer Straße 65  
35305 Grünberg  
Germany

Tel.: +49 6401 807-0  
info@bender.de  
www.bender.de

Alle Rechte vorbehalten.  
Nachdruck und Vervielfältigung nur mit  
Genehmigung des Herausgebers.

All rights reserved.  
Reprinting and duplicating only with  
permission of the publisher.

© Bender GmbH & Co. KG, Germany  
Subject to change! The specified  
standards take into account the edition  
valid until unless otherwise indicated.

