



COMTRAXX® CP9xx – Control Panel

Remote alarm indicator and operator panel
for medical locations and other areas
Software version V4.9.x



Table of contents

1	General information.....	5
1.1	How to use the manual.....	5
1.2	Indication of important instructions and information.....	5
1.3	Service and Support.....	5
1.4	Training courses and seminars.....	5
1.5	Delivery conditions.....	5
1.6	Inspection, transport and storage.....	6
1.7	Warranty and liability.....	6
1.8	Disposal of Bender devices.....	6
1.9	Safety.....	7
2	Product description.....	8
2.1	Intended use.....	8
2.2	Scope of delivery.....	8
2.3	Device features.....	8
2.4	Possible applications.....	9
2.5	Configuration, diagnosis, service.....	9
2.6	Optional accessories.....	9
2.7	Software products used.....	10
2.8	Applications.....	10
2.9	Functional description.....	10
2.9.1	Interfaces.....	10
2.9.2	Process image.....	11
2.9.3	Control of operating theatre lights.....	11
3	Mounting, wiring and commissioning.....	13
3.1	Mounting.....	13
3.2	Mounting CP907.....	14
3.2.1	Flush mounting enclosure CP907.....	14
3.2.2	Surface-mounting enclosure CP907.....	15
3.3	Mounting CP915/CP924.....	16
3.3.1	Flush-mounting enclosure CP915/CP924.....	16
3.3.2	Removing the CP915/924 front plate.....	18
3.4	Connection of the device.....	19
3.5	Digital inputs.....	24
3.6	Relay.....	25
3.7	Commissioning of the device.....	25

3.7.1	BMS interface.....	26
3.7.2	Address configuration and termination.....	26
3.7.3	Browser configuration.....	26
3.7.4	Software products used.....	26
3.8	COMTRAXX® user interface.....	27
4	Modbus TCP server.....	28
5	Troubleshooting.....	29
5.1	Malfunctions.....	29
5.1.1	What should be checked?.....	29
5.1.2	Frequently asked questions.....	29
5.2	Device operation, Maintenance, Cleaning.....	29
6	Technical data.....	30
6.1	Factory settings.....	30
6.2	Tabular data.....	30
6.3	Standards, approvals and certifications.....	38
6.4	Ordering information CP9xx.....	38
6.5	Document revision history.....	39

1 General information

1.1 How to use the manual

**ADVICE**

This manual is intended for qualified personnel working in electrical engineering and electronics! Part of the device documentation in addition to this manual is the enclosed supplement "Safety instructions for Bender products".

**ADVICE**

Read the operating manual before mounting, connecting and commissioning the device. Keep the manual within easy reach for future reference.

1.2 Indication of important instructions and information

**DANGER**

Indicates a high risk of danger that will result in death or serious injury if not avoided.

**WARNING**

Indicates a medium risk of danger that can lead to death or serious injury if not avoided.

**CAUTION**

Indicates a low-level risk that can result in minor or moderate injury or damage to property if not avoided.

**ADVICE**

Indicates important facts that do not result in immediate injuries. They can lead to malfunctions if the device is handled incorrectly.



Information can help to optimise the use of the product.

1.3 Service and Support

Information and contact details about customer service, repair service or field service for Bender devices are available on the following website: Fast assistance | Bender GmbH & Co. KG.

1.4 Training courses and seminars

Regular face-to-face or online seminars for customers and other interested parties:

www.bender.de > know-how > seminars.

1.5 Delivery conditions

The conditions of sale and delivery set out by Bender GmbH & Co. KG apply. These can be obtained in printed or electronic format.

1.6 Inspection, transport and storage

Check the shipping and device packaging for transport damage and scope of delivery. In the event of complaints, the company must be notified immediately, see "www.bender.de > service & support".

When storing the devices, observe the information under Environment / EMC in the technical data.

1.7 Warranty and liability

Warranty and liability claims for personal injury and property damage are excluded in the case of:

- Improper use of the device.
- Incorrect mounting, commissioning, operation and maintenance of the device.
- Failure to observe the instructions in this operating manual regarding transport, commissioning, operation and maintenance of the device.
- Unauthorised changes to the device made by parties other than the manufacturer.
- Non-observance of technical data.
- Repairs carried out incorrectly.
- The use of accessories or spare parts that are not provided, approved or recommended by the manufacturer.
- Catastrophes caused by external influences and force majeure.
- Mounting and installation with device combinations not approved or recommended by the manufacturer.

This operating manual and the enclosed safety instructions must be observed by all persons working with the device. Furthermore, the rules and regulations that apply for accident prevention at the place of use must be observed.

1.8 Disposal of Bender devices

Abide by the national regulations and laws governing the disposal of this device.



Bender GmbH & Co. KG is registered in the waste from electrical and electronic equipment (WEEE) register under the WEEE number: DE 43 124 402. For more information on the disposal of Bender devices, refer to www.bender.de > service & support.

1.9 Safety

If the device is used outside the Federal Republic of Germany, the applicable local standards and regulations must be complied with. In Europe, the European standard EN 50110 applies.



DANGER Risk of fatal injury due to electric shock!

Touching live parts of the system carries the risk of:

- Risk of electrocution due to electric shock
- Damage to the electrical installation
- Destruction of the device

Before installing the device and before working on its connections, make sure that the installation has been de-energised. The rules for working on electrical systems must be observed.

2 Product description

This manual describes

- The COMTRAXX® **CP907**-Control Panel
- The COMTRAXX® **CP915**-Control Panel
- The COMTRAXX® **CP924**-Control Panel

Alarm indicator and operator panels play a decisive role at the interfaces between man and machine. Their task is to alert visually and acoustically and to convert information from the system into comprehensible operating and action instructions. This applies in particular when critical operational situations are developing. The CP9xx-Control Panel offers the user a solution that meets the requirements of modern medical locations as well as industrial and purpose-built buildings.

2.1 Intended use

Remote alarm indicator and operator panels CP9xx display alarms, measured values and states of devices. These include, for example:

- All Bender devices with BMS bus or BCOM interface
- Bender devices (PEM, energy meters,...) with Modbus RTU or Modbus TCP interface
- Other devices with Modbus RTU or Modbus TCP interface

In addition, the data is available via Modbus TCP, Modbus RTU, SNMP, MQTT and PROFINET protocols. This allows coupling to a higher-level building control system as well as visualisation and evaluation using standard web browsers.

Operation and settings are made via the COMTRAXX® user interface integrated in the device.

Any other use than that described in this manual is regarded as improper.

2.2 Scope of delivery

Included within the scope of delivery

- A CP9xx alarm indicator and operator panel
- A printed quick-start guide
- Safety instructions for Bender products
- The manuals "COMTRAXX® CP9xx" and "BCOM" are available as PDF files for download at <https://www.bender.de/en/service-support/download-area/>

For CP915 and CP924 additionally

- Connecting cable
- Ethernet-Keystone coupler
- USB cable
- RJ45 flat patch cable

2.3 Device features

- Display sizes 7", 15" and 24" with tempered and anti-reflective glass
- Easy to clean and disinfect, degree of protection IP54
- Screwless mounted front plate
- User-friendly touch-sensitive monitoring system for medical locations and other applications
- Particularly simple operation

- Additional information for medical and technical personnel
- Visual and acoustic notification in the event of an alarm
- Clear menu structure with intuitive interactive images
- Clearly labelled safety functions
- Silent due to operation without fan
- High-quality display with excellent contrast, high resolution and wide viewing angle
- Possibility of graphical integration of building plans or status displays in photo quality
- Easy integration of external equipment like charging stations for operating theatre table controls and intercom systems with front foil
- Simple conversion and expansion with minimal service interruptions

2.4 Possible applications

Monitoring, operation and display of

- Medical IT systems
- Supply systems for medical gases
- HVAC systems
- Room lighting
- Operating theatre lights
- Special power supply systems (BSV or UPS)
- Other systems from different manufacturers

2.5 Configuration, diagnosis, service

Each panel can be individually manufactured and tailored to the requirements of the user. The integration of the technical equipment into a single panel creates a technical monitoring centre. It provides diagnostic options through an overall system overview from a central location via a web browser, supported by data loggers and history memory.

Optional parameter setting (setting limit values, entering individual customer texts, editing the system configuration, etc.) is available.

2.6 Optional accessories

- The remote I/O system offers numerous options for integrating digital and analogue I/Os with different operating voltages, capacities, measurement signals or special functions into the alarm indicator and operator panel.
- Communication with building management systems via common interfaces such as Modbus TCP, Modbus RTU, PROFIBUS, KNX, LonWorks, Sercos interface, InterBus, Dali, CANopen, EtherNet/IP, CC-Link, DeviceNet, BACnet, PROFINET.

The result is an all-round system that is both modular and flexible and can thus be adapted, expanded or connected to new technologies.

Other project-specific versions with foil front or with additional internal components available on request:

- Charging trays for operating theatre table remote controls
- Intercom systems
- Operating theatre light controls
- Programmable backlit keypads
- Digital/Analogue inputs/outputs for installation in panel enclosures or control cabinets

- Data coupling to third-party systems
- Project-specific installation enclosures
- Integration of third-party equipment
- Matt surface or highly transparent foil options available
- Replacement of existing panels (retrofitting)

2.7 Software products used

CP9xx devices are equipped with the COMTRAXX® user interface. It is described in the manual D00418.

2.8 Applications

- Optimal visualisation on the display tailored to the user
- Integration of all compatible Bender products (ISOMETER®, ATICS®, RCMS, EDS, LINETRAXX® and MEDICS® systems, universal measuring devices and energy meters)
- Individual instructions in case of alarms
- Selective notification to various users in case of alarms
- Control and regulation of systems such as air conditioning or blinds control.

2.9 Functional description

2.9.1 Interfaces

CP9xx communicate with the devices and systems assigned via various interfaces:

- Internal BMS bus (RS-485) for Bender systems such as EDS46.../49..., RCMS46.../49... and MEDICS®. CP9xx can be operated as a master or as a slave. When operated as a master, requests are answered more quickly. The devices can only be operated on the internal BMS bus.
- BCOM (Ethernet) for new and future Bender systems, such as ISOMETER® iso685-D.
- Modbus RTU (RS-485)
CP9xx when operated as a master for Bender devices PEM... with restricted functionality (full functionality of PEM...5 only via Modbus TCP).
- Modbus TCP (Ethernet) for Bender devices PEM...5

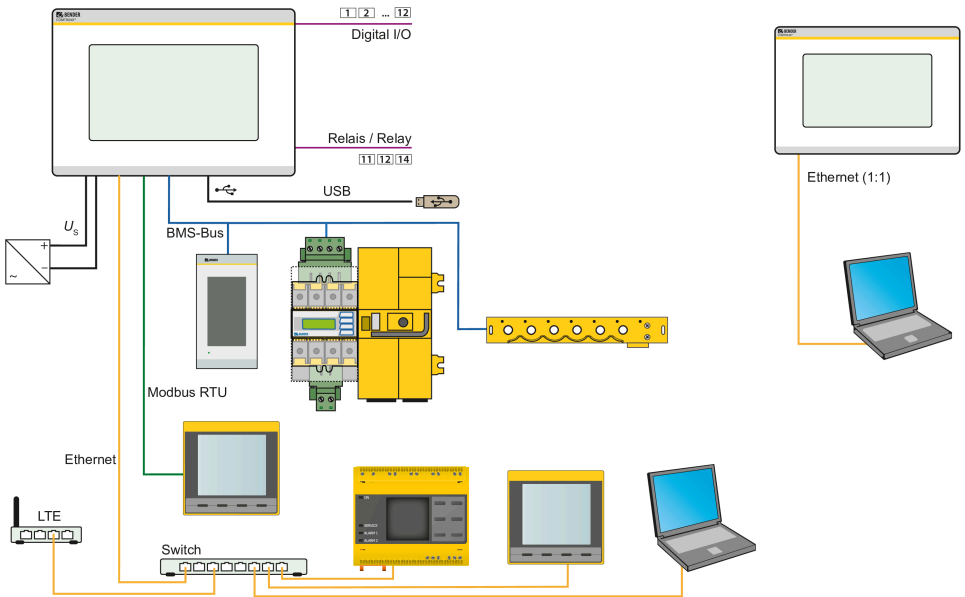

Figure 2-1: System overview interfaces CPxx

i For safe operation of the Medics® system in accordance with IEC 60364-7-710 and IEC 61557-8, it is recommended to operate the self-monitoring system with a second master-capable device from the Control Panel family.

2.9.2 Process image

The CP9xx alarm indicator and operator panel combines the information from the different interfaces and makes it available for operation and visualisation via the web user interface of a PC.

It acts as a central user interface. In order to be able to identify them, one individual address is available for each device on this interface. BMS, BCOM and Modbus RTU devices receive the appropriate address for their interface. A virtual address is assigned to Modbus TCP devices.

2.9.3 Control of operating theatre lights

Operating theatre lights from different manufacturers can be controlled via the CP9xx. Most operating theatre lights feature a USB or RS-232 interface. The CP9xx can be connected via this interface. RS-232 interfaces require a converter from RS-232 to USB. The control (and the communication protocol) was tested and verified together with the operating theatre light manufacturers.

The functionality and design of the CP9xx controls are adapted to that of the operating theatre lights. The operating theatre light functions can be parameterised for specific projects in the CP9xx interface. In general, only the functions provided by the communication boxes of the respective manufacturers can be used.

The installation instructions of the communication boxes can be found in the documentation provided by the manufacturer. The manufacturer is also responsible for service. An overview of the supported operating theatre lights can be found in the document D00349_N_DEEN.

3 Mounting, wiring and commissioning



Only **qualified personnel** are permitted to carry out the work necessary to install, commission and run a device or system.



CAUTION **Protective earth**

The device must be earthed. Without connection of the protective earth, the device function is not guaranteed.

Electrostatic sensitive components

Observe the precautions for handling electrostatic sensitive devices.

Damage to components

Do not remove the device from the enclosure while it is in operation. Disconnect the device from the supply voltage and from the network (Ethernet) beforehand.

Damage to the device due to incorrect connector plug

Connector plugs of other devices may have different polarity. Make sure to use the supplied connector plug.

Protective separation

The power supply must be properly separated from hazardous voltages and meet the limit values of UL/CSA 61010-1, clause 6.3.

The CP9xx touch panel can be integrated into existing LAN structures or operated via a single PC.

i If you are familiar with the configuration of computer networks, you can carry out the connection of the CP9xx alarm indicator and operator panel yourself. Otherwise please contact your IT administrator!

i Ethernet cables connected directly to the device cannot go outside the building.

3.1 Mounting

The COMTRAXX® CP9xx devices are installed

- either in the supplied and professionally pre-assembled flush-mounting enclosures
 - or in an optionally available surface-mounting enclosure (CP907 only)
- Special variants with modified enclosure depths or surface-mounted variants are available on request.

Dimension diagram

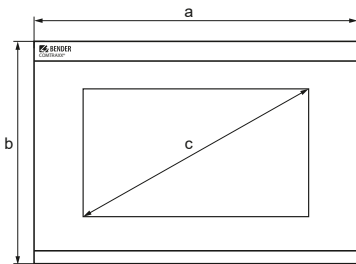

Glass thickness: 3 mm

Device dimensions

Type	Dimensions (mm) ±1		
	a	b	c
CP907	226	144	176 (7")
CP915	505	350	386 (15.6")
CP924	654	441	610 (24")

Installation dimensions enclosure

Type	Enclosure	Dimensions (mm)		Required installation depth
		a	b	
CP907	Flush-mounting	212	124	75
	Surface-mounting	299	173	---
CP915	Flush-mounting	464	309	92
CP924	Flush-mounting	613	401	95

3.2 Mounting CP907

3.2.1 Flush mounting enclosure CP907



For UL applications

In case of flush-mounting a suitable and approved housing must be used.



CAUTION Malfunction due to incorrect installation

The supplied flush-mounting enclosures are only suitable for mounting in cavity walls.

In drywall and stud frame constructions, the enclosures must be screwed horizontally to the battens or stud frame. The enclosure must be mounted **horizontally**.

The enclosure sides must be at right angles to each other and must not warp during mounting!

The wall surface must be even.

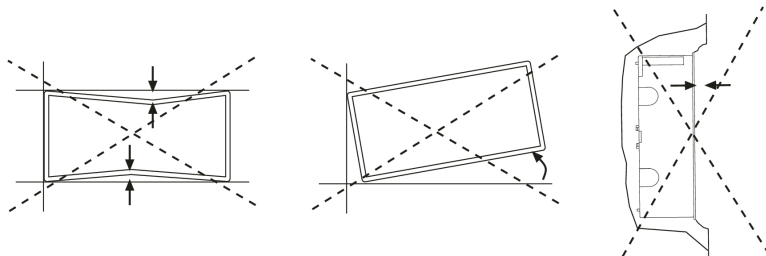

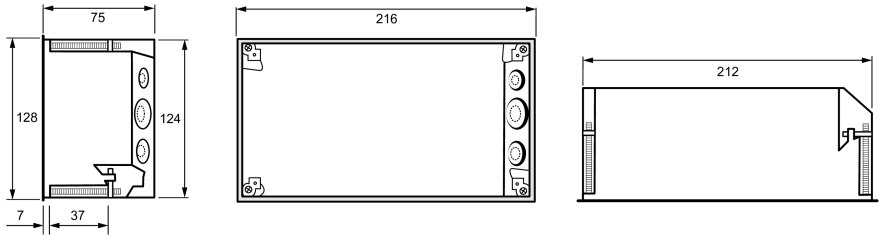

Flush mounting enclosure CP907, dimensions in mm



Installation dimensions flush-mounting enclosure = enclosure dimensions + 3 mm

3.2.2 Surface-mounting enclosure CP907

For surface mounting, the flush-mounting enclosure is mounted in the optionally available surface-mounting enclosure (B95061915).

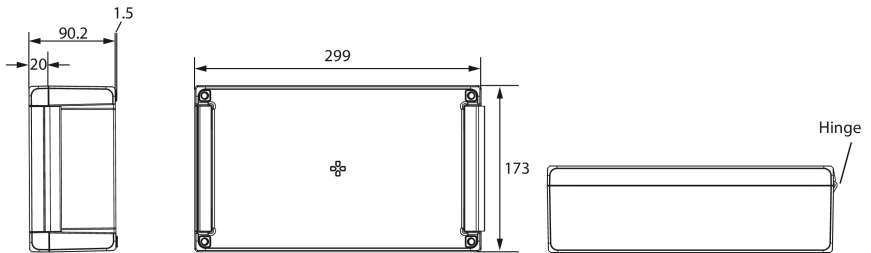

Enclosure for surface mounting CP907, dimensions in mm

Mounting procedure

1. Assemble the surface-mounting enclosure (fit hinges and bracket).
2. Insert the flush-mounting enclosure through the opening in the cover. Fit the enclosed plastic frame from behind and screw it in place using the fasteners of the flush-mounting enclosure.
3. Make the required cable openings in both enclosures.
4. Connect the CP907 and mount it in the enclosure.

3.3 Mounting CP915/CP924

3.3.1 Flush-mounting enclosure CP915/CP924

Mounting



For UL applications

In case of flush-mounting a suitable and approved housing must be used.



CAUTION Malfunction due to incorrect installation

The supplied flush-mounting enclosures are only suitable for mounting in cavity walls.

In drywall and stud frame constructions, the enclosures must be screwed horizontally to the battens or stud frame. The enclosure must be mounted **horizontally**.

The enclosure sides must be at right angles to each other and must not warp during mounting!

The wall surface must be even.

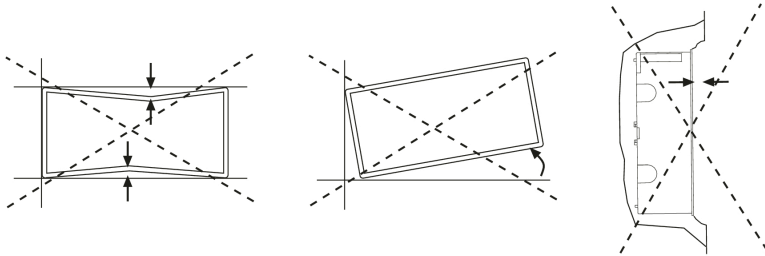

Attachment frame

An attachment frame can be used for uneven wall surfaces.
The dimensions "a" and "b" are adapted to the specific project.

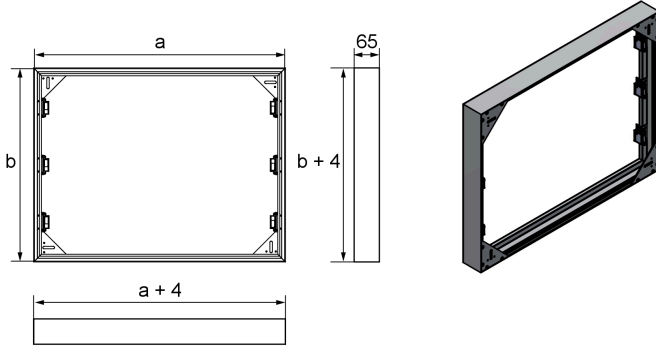

Attachment frame CP9xx, dimensions in mm

Assembly instructions can be found here:  COMTRAXX® CP9xx
Attachment frame
Video instruction

Dimensions flush-mounting enclosure

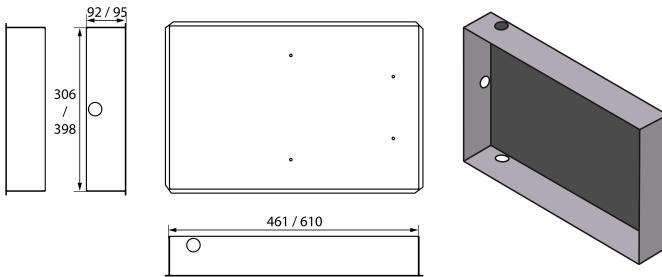

Flush-mounting enclosure CP915/CP924, dimensions in mm



Installation dimensions flush-mounting enclosure = enclosure dimensions + 3 mm

CP924 portrait mode

If needed, **vertical installation** (portrait mode) is also possible. This requires a different flush-mounting enclosure and a customised front with rotated printing (see "Ordering information CP9xx", page 38).

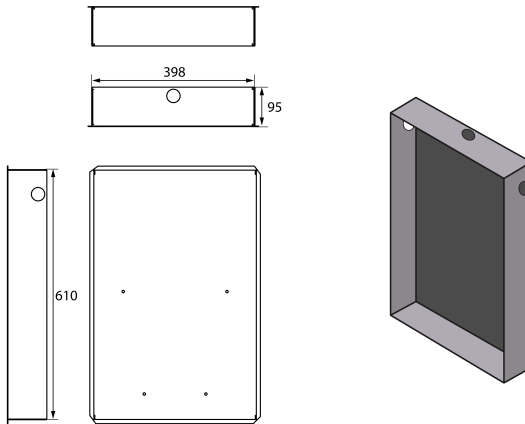

Flush-mounting enclosure CP924 portrait mode, dimensions in mm



Installation dimensions flush-mounting enclosure = enclosure dimensions + 3 mm

3.3.2 Removing the CP915/924 front plate

Removing the front plate

The front plate is removed from the enclosures of the CP915/924 devices using two suction lifters.



CAUTION Damage to the device

Prying out the front panel with screwdrivers, fingernails or similar tools will damage both the seal and the glass of the front panel.

Always use suction lifters to release the front panel!

The suction lifters must be positioned at the points marked in the figure. Loosen the front panel up to the first latching point and lift it out of the enclosure.



CAUTION Damage to the display front

Placing the suction lifter in the middle and pulling only at this point may damage the front plate. Always place the suction lifter on the edges of the display.



3.4 Connection of the device

The CP9xx is integrated into existing LAN structures, but can also be operated via a single PC.



Configuration of computer networks

If you are familiar with the configuration of computer networks, you can carry out the connection of the device yourself. **Otherwise please contact your IT administrator!**



Ethernet

The shield of the Ethernet cable must be connected to PE on both sides.



For UL applications

Use copper lines only. Minimum temperature range of the wires to be connected to the plug-in terminals: 75 °C.

In case of flush-mounting a suitable and approved housing must be used.



PoE (CP907 only)

Minimum temperature range of the cables (copper lines) to be connected to the PoE Ethernet connection: 80 °C

For operation via PoE, the voltage transmitter (router) must meet one of the following requirements:

- Class 2 requirement acc. to UL1310 or
- Limited power source requirement acc. to UL 60950 or
- Limited energy circuit requirement acc. to UL 61010.

With a pure PoE supply, it is not possible to supply the I²C expansion modules. Maximum I²C cable length < 3 m.

Remove the CP9xx from the built-in flush-mounting enclosure.

Mainboard and connections of the CP9xx

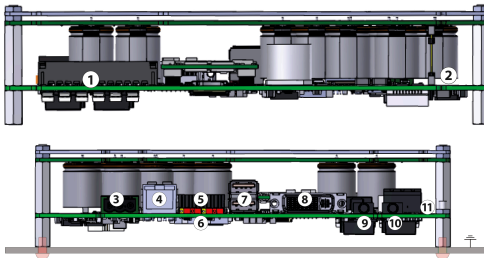

No.	Connection	CP907	CP915/CP924
1	Plug connector digital inputs		
2	Plug connector to energy storage board		
3	Voltage supply A1/+, A2/-, PE*		
4	Ethernet (RJ45/CAT5); HTTP, Modbus TCP, BCOM	with PoE	without PoE

No.	Connection	CP907	CP915/CP924
5	X1 plug connector for Modbus RTU, BMS bus		
6	Termination of Modbus RTU and BMS bus		
7	USB ports (for touch sensor)	not included	
8	DVI output	not included	
9	Audio output	not included	
10	Audio input	not included	
11	Connection to control relay		



CAUTION

* **CP915/924: Protective earth (PE)**

It is mandatory to earth the device. Without connection of the protective earth (PE), the function of the device is not guaranteed.



CAUTION

The **digital inputs and relay outputs** must not be connected directly to the power supply network or to the power supply unit that supplies the CP9xx.

Use a separate, galvanically isolated power supply unit!

Connect the device as follows:

1. Modbus RTU connection (5): Connect terminals **AMB** and **BMB** to the Modbus RTU (A to A, B to B).
2. BMS bus connection (5): Connect terminals **ABMS** and **BBMS** to the BMS bus (A to A, B to B)

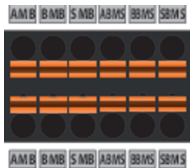

X1 plug assignment (5)

3. If the CP9xx is located at the beginning or end of the respective bus (Modbus RTU and BMS), the respective terminating switch of the device (6) must be switched to "ON".

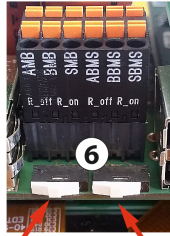

Modbus RTU
R_off | R_on BMS
R_off | R_on

4. Establish connection with PC and BCOM:
Connect the CP9xx device to the PC network using an Ethernet cable (4).
5. Link digital inputs.
See chapter “Digital inputs”, page 24.
6. Connect the control relay (11):

Connection relay

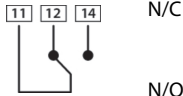

N/C

N/C operation contacts 11-12

(the alarm relay is energised during normal operation).

N/O

N/O operation contacts 11-14

(the alarm relay is de-energised during normal operation).

7. Connect the power supply.



CAUTION

Protective earth

The device must be earthed. Without connection of the protective earth, the device function is not guaranteed.

Electrostatic sensitive components

Observe the precautions for handling electrostatic sensitive devices.

Damage to components

Do not remove the device from the enclosure while it is in operation. Disconnect the device from the supply voltage and from the network (Ethernet) beforehand.

Damage to the device due to incorrect connector plug

Connector plugs of other devices may have different polarity. Make sure to use the supplied connector plug.

Protective separation

The power supply must be properly separated from hazardous voltages and meet the limit values of UL/CSA 61010-1, clause 6.3.



For UL and CSA applications, the supply voltage must be protected via 5 A fuses.

Connect PE to earth. Connect terminals A1/+ and A2/- (3) to the power source.

The CP907 can also be supplied via Power-over-Ethernet (PoE). **The PoE switch must be earthed.** For further details, see technical data.

8. Attach the front plate to the built-in flush-mounting enclosure.

CP907 is mounted. The following steps apply to CP915/924 only:

9. Connect the front panel to the control board and the power supply:
Connect a USB socket (7) to the touch sensor connector on the front panel. Associated connection cable included in the scope of delivery.

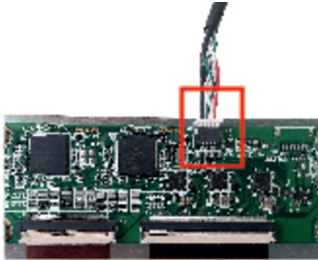

10. Connect the screen output DVI (8) to the front plate. DVI cable: Cable length < 3 m, connect firmly to PE on both sides.

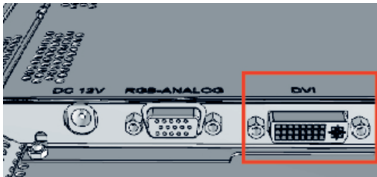

11. When using the audio output (9), an electrically isolated amplifier must be used.
12. Connect the voltage supply to the power supply unit via the pre-assembled wiring. Connect the earthing to the front plate.

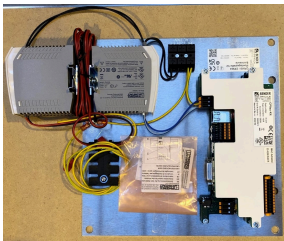

Pre-assembled voltage supply

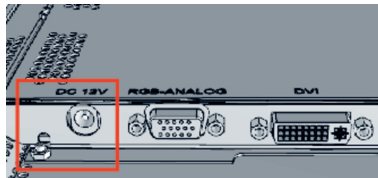

Connection earthing on front plate

i The dual power supply unit supplies the CP915 or CP924 with 24 V and the display with 12 V.

13. **CP915:** Attach the front plate to the built-in flush-mounting enclosure.

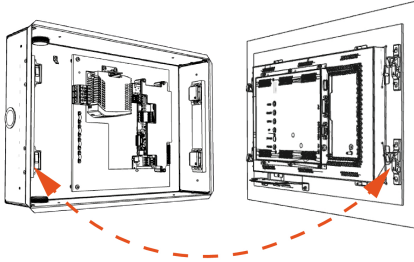

14. **CP924:** Hold the display unit from above in front of the flush-mounting enclosure. Place the two mounting hooks behind the upper snap locks of the flush-mounting enclosure (see red markings). Lower the display and slide it into the flush-mounting enclosure.

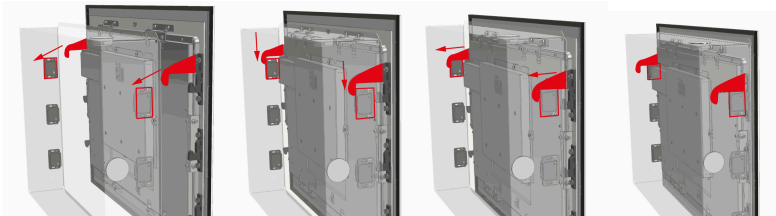

15. When pushing in the display, the spring force of the snap locks must be overcome. Make sure that no wiring gets jammed in the process.

16. When removing the display unit, it is important that you only place the suction lifters in the side area of the display and carefully remove the display unit from the snap locks.

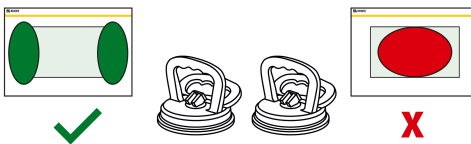

3.5 Digital inputs

CP9xx-devices feature 12 configurable digital inputs. Settings are made via the COMTRAXX® user interface in a browser.

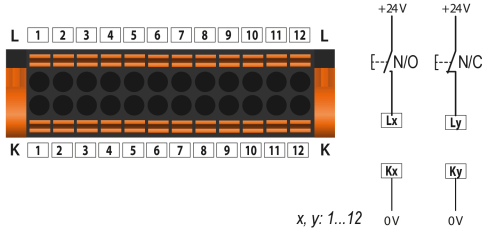

Function

The following functions can be assigned to the digital inputs:

- off Digital input without function
- TEST Self test of the device
- RESET Reset fault and alarm messages

Menu > Settings > Digital input 1 - 12

For each of the 12 digital inputs DI1...12, the following can be defined:

Parameter	Options/Setting range	
Mode	High-active Low-active Impuls (High-active) Impuls (Low-active)	
Measurement type	Operating message Alarm Error(s)	
t_{on}	Response delay	0 s...10 minutes
t_{off}	Switch-off delay	

An event is executed when the digital input experiences an edge change. The edge change must be present at least for the set response delay t_{on} , otherwise it is ignored.

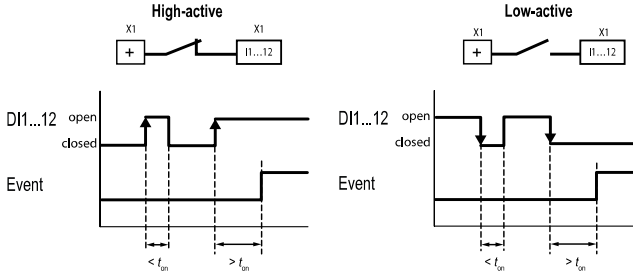

3.6 Relay

Connection relay

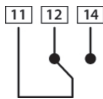

N/C

N/C operation contacts **11-12**
(the alarm relay is energised during normal operation).

N/O

N/O operation contacts **11-14**
(the alarm relay is de-energised during normal operation).

3.7 Commissioning of the device

1. Switch on the supply voltage:
After switching on, the device performs a start routine. It is completed when the commissioning page appears on the display.



2. Enter the desired IP address in the 1st line
3. Enter the subnet mask in the 2nd line
4. Enter the address of the default gateway.
5. Press the "Save" button to store the entries.
6. Wait 8...10 seconds. The COMTRAXX® system overview starts.

7. If there is a DHCP server in the network, select only the check box to the right of the "DHCP?" label in line 4. Confirm your selection by pressing the "Save" button. The network settings transmitted from the server are shown on the display after 8...10 seconds.



After this, the commissioning must be continued via the COMTRAXX® user interface.

3.7.1 BMS interface

The majority of Bender devices communicate via the internal BMS bus. CP9xx can be operated as a master or as a slave.



CP9xx is to be operated as a master if:

- Parameters are queried or changed
- Certain control commands are issued

Note that not all BMS masters can surrender their master function!

- From an external application (e.g. visualisation software), commands can be sent to BMS devices. The "Modbus control commands" menu provides Modbus control commands for selected BMS commands. These commands can be copied to the clipboard of the PC and then included in the programming of the external application.
- Graphical display with scaling of the time axis for the data loggers of the gateway and compatible Bender devices.

3.7.2 Address configuration and termination

To ensure proper functioning of the CP9xx, correct address assignment and termination is of utmost importance.



Multiple assignment of addresses

The factory setting for the system name on all Bender BCOM devices is "SYSTEM". If several systems with the same system name are integrated into the same network, addresses are assigned twice. This leads to transmission errors.

Always enter a unique BCOM system name during initial configuration.

3.7.3 Browser configuration

The latest version of Google Chrome, Microsoft Edge or Mozilla Firefox is recommended.

3.7.4 Software products used

Select  **Tools > Information > Copyright**, to display the used software products.

3.8 COMTRAXX® user interface

The device has a web user interface for setting and operation. How to start the web user interface:

- Open an Internet browser from any network device.
- Enter the address of the CP9xx device in the address line of the browser.





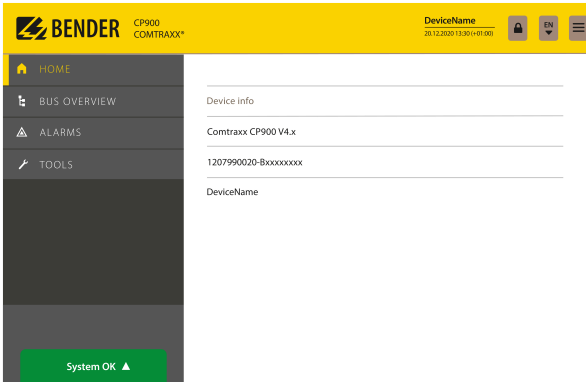

It is possible to connect the CP9xx directly to a computer/laptop. In this case, the CP9xx can be addressed via a second fixed IP address.

- Open the browser on the connected device.
- Enter the following IP address: 169.254.0.1

The start screen of the COMTRAXX® user interface appears in the browser window.



Start screen of the COMTRAXX® user interface

-  Login to the device
-  Language selection
-  EN
-  Show/Hide Menu
-  System is without faults
-  Alarms (number of alarms)

 **COMTRAXX® documentation**
 Further information on functionality and configuration of the CP9xx is described in the manual D00418.

4 Modbus TCP server

The Modbus TCP server supports the following function codes:

- Function code **0x03** (Read Holding Registers)
- Function code **0x04** (Read Input Registers)
- Function code **0x10** (Preset Multiple Registers)

The Modbus TCP server generates a function-related response to requests and sends it back to the Modbus TCP client.

i *Detailed information as well as examples on Modbus TCP and system images can be found in the manual D00418.*

5 Troubleshooting

5.1 Malfunctions

If the device causes malfunctions in the connected networks, please refer to this manual.

5.1.1 What should be checked?

Check whether

- the device is supplied with the correct supply voltage U_S .
- the BMS bus cable is correctly connected and terminated (120 Ω).
- the BMS address is set correctly.
- the BCOM address settings are correct.
- the power supply cable to the display is plugged in firmly.
- the video cable is plugged in firmly.
- the USB cables are plugged in firmly.

5.1.2 Frequently asked questions

How do I access the device if the address data are unknown?

1. Connect the device directly to a PC using a patch cable
2. Activate the DHCP function on the PC.
3. Wait around one minute.
4. Access is now possible using the following pre-defined IP address: **169.254.0.1**.
5. Now set the new address data.

i Document the new settings as a PDF file. Use the backup function to save all settings of the device (see Chapter: "Device features", page 8).

Frequently asked questions on the Internet

FAQs on many Bender devices can be found at:

www.bender.de/en > service-support > fast-assistance

5.2 Device operation, Maintenance, Cleaning

Device operation

The device can be operated with latex, vinyl and nitrile gloves without impairing functionality.

Maintenance

The device does not contain any parts that require maintenance.

Cleaning

The glass front can be cleaned with common cleaning agents. Glass and seal are resistant to alcoholbased disinfectants.

6 Technical data

6.1 Factory settings

Factory settings communication addresses

Parameter	Factory setting
IP address	-
IP address for 1:1 ETH conn.	169.254.0.1
Net mask	255.255.0.0
Standard gateway	192.168.0.1
DNS	-
DHCP	off
t_{off} Timeout for address assignment	30 s
BMS address	1
BMS protocol	BMS i
BCOM system name	SYSTEM
Subsystem address	1
BCOM device address	1

The settings can be changed during commissioning via the display or the web user interface.

6.2 Tabular data

Insulation coordination acc. to IEC 60664-1

CP907

Rated voltage	50 V
Overtoltage category	III
Pollution degree	2
Rated impulse voltage	800 V

CP915 / CP924

Rated voltage	AC 250 V
Overtoltage category	III
Overtoltage category for UL applications	II
Pollution degree	2
Rated impulse voltage	4 kV

Supply

CP907 via plug-in terminal (A1/+; A2/-)

Nominal voltage	DC 24 V SELV/PELV
Nominal voltage tolerance	±20 %
Typical power consumption at DC 24 V	< 15 W
Maximum cable length when supplied via B95061210 (24-V DC power supply unit 1.75 A):	
0.28 mm ²	75 m
0.5 mm ²	130 m
0.75 mm ²	200 m
1.5 mm ²	400 m
2.5 mm ²	650 m

CP907 via Power-over-Ethernet (PoE)

Nominal voltage	DC 48 V SELV/PELV
Nominal voltage tolerance	-25...+15 %
Typical power consumption for PoE	< 15 W
Maximum cable length when supplied via AWG 26/7; 0.14 mm ²	100 m

CP915 via terminal block (L1; N)

Nominal voltage via external power supply unit	AC 100... 240 V
Nominal voltage tolerance	-15...+10 %
Frequency range U_S	50...60 Hz
Typical power consumption at AC 230 V	< 30 W

CP924 via terminal block (L1; N)

Nominal voltage via external power supply unit	AC 100... 240 V
Nominal voltage tolerance	-15...+10 %
Frequency range U_S	50...60 Hz
Typical power consumption at AC 230 V	< 55 W

Stored energy time in the event of voltage failure

Time, date	min. 3 days
------------	-------------

Displays, memory

Display CP907/Resolution	7" TFT-Touch Display/800 x 480
Display CP915/Resolution	15.6" TFT-Touch Display/1280 x 720
Display CP924/Resolution	24" TFT-Touch Display/1280 x 720 or 1920 x 1080
E-mail configuration and device failure monitoring	Max. 250 entries
Individual texts	Unlimited number of texts with 100 characters each
Number of data points for "third-party devices" to Modbus TCP and Modbus RTU	1600
Number of data loggers	30
Number of data points per data logger	10,000
Number of entries in the history memory	20,000

Visualisation

Number of pages	50
Background image size	max. 3 MB

Interfaces

Ethernet	
Connection	RJ45
Cable	Shielded, both ends of shield connected to PE
Cable length	< 100 m
Data rate	10/100 Mbit/s, autodetect
HTTP mode	HTTP/HTTPS (HTTP)*
DHCP	On/off (off)*
t_{off} (DHCP)	5...60 s (30 s)*
IP address	nnn.nnn.nnn.nnn (192.168.0.254)*, Always reachable via 169.254.0.1
Net mask	nnn.nnn.nnn.nnn (255.255.0.0)*
Protocols	TCP/IP, Modbus TCP, Modbus RTU, PROFINET, DHCP, SNMP, SMTP, NTP

BMS-Bus

Interface/protocol	RS-485/BMS internal
Operating mode	Master/slave (master)*
Baud rate	9.6 kBaud
Cable length	< 1200 m

BMS-Bus

Cable	Shielded, one end of shield connected to PE
recommended	CAT6/CAT7 min. AWG23
alternative	Twisted pair, J-Y (St) Y min. 2x0.8
Connection	"ABMS", "BBMS" (see plug-in terminal)
Terminating resistor	120 Ω (0.25 W), can be switched on internally (see plug-in terminal)
Device address	1...150 (1)*

BCOM

Interface/protocol	Ethernet/BCOM
Cable length	< 100 m
BCOM system name	(SYSTEM)*
BCOM subsystem address	1...255 (1)*
BCOM device address	0...255 (1)*

Modbus

Bender Modbus image	V1, V2 (V2)*
---------------------	--------------

Modbus TCP

Interface/protocol	Ethernet/Modbus TCP
Cable length	< 100 m
Operating mode	Client for Bender Modbus TCP devices and "third-party devices"
Operating mode	Server for access to process image and for Modbus control commands
Parallel data access from different clients	max. 25

Modbus RTU

Interface/protocol	RS-485/Modbus RTU
Cable	Shielded, one end of shield connected to PE
recommended	CAT6/CAT7 min. AWG23
alternative	Twisted pair, J-Y (St) Y min. 2x0.8
Cable length	Depending on the baud rate
9.6 kBaud	< 1200 m
19.2 kBaud	< 1000 m
38.4 kBaud	< 800 m
57.6 kBaud	< 600 m

Modbus RTU

Connection	"AMB", "BMB" (see plug-in terminal)
Operating mode	Master/slave (master)*
Baud rate	9.6...57.6 kBaud
Terminating resistor	120 Ω (0.25 W), can be connected internally (see plug-in terminal)
Supported Modbus RTU slave addresses	2...247

PROFINET

Interface/protocol	Ethernet/PROFINET
Operating mode	Slave (IO device)

SNMP

Interface/protocol	Ethernet/SNMP
Versions	1, 2c, 3
Supported devices	Query of all devices (channels) possible
Trap support	No

MQTT

Interface/protocol	Ethernet/MQTT
Operating mode	Publisher (provides data for brokers)
Slots for measured value transmission	255

USB

Number	2
Operating mode	USB-2.0 host (5 V, 500 mA)
Data rate	480 Mbit/s
Cable length	< 3 m
Connection type	USB 2 Standard-A

Used ports

53	DNS (UDP/TCP)
67, 68	DHCP (UDP)
80	HTTP (TCP)
123	NTP (UDP)
161	SNMP (UDP)

443	HTTPS (TCP)
502	MODBUS (TCP)
4840	OPCUA (TCP)
5353	MDNS (UDP)
48862	BCOM (UDP)

Digital inputs (1...12)

Number	12
Galvanic separation	Ja
Maximum cable length	< 1000 m
Operating mode	Selectable for each input: high-active or low-active
Factory setting	High-active
Voltage range (high)	AC/DC 10...30 V
Voltage range (low)	AC/DC 0...2 V
Max. current per channel (at AC/DC 30 V)	8 mA
Connection push-in terminal	(1-1) (2-2) (3-3) ... (12-12)

Switching elements

For UL applications

Type of load: General use

Voltage connected to relay: SELV

Number	1 relay
Operating mode	N/C operation or N/O operation
Function	Programmable
Electrical endurance under rated operating conditions, number of cycles	10,000
Contact data acc. to IEC 60947-5-1	
Utilisation category	AC-13 / AC-14 / DC-12
Rated operational voltage	24 V / 24 V / 24 V
Rated operational current	2 A / 2 A / 2 A
Minimum contact load (relay manufacturer's reference)	10 µA / 10 mV DC
Connection plug-in terminal	(11;12;14)

Buzzer

Buzzer message	Can be acknowledged, adoption of characteristics of new value
Buzzer interval	Configurable
Buzzer frequency	Configurable
Buzzer repetition	Configurable

Audio

Line IN	Not used
Line OUT	Output to a STEREO playback device via 3.5 mm jack plug
Cable length	< 3 m

Device connections

Terminal block (L1; N; PE) (for CP915 and CP924 only)

Conductor sizes	AWG 20...12
Stripping length	10...11 mm
rigid/flexible	0.5...4 mm ²
flexible with ferrule with/without plastic sleeve	0.5...4 mm ²
Multiple conductor, flexible with TWIN ferrule with plastic sleeve	0.5...4 mm ²

Plug-in terminal (A1/+; A2/-) (11;12;14)

Conductor sizes	AWG 24...12
Stripping length	10 mm
rigid/flexible	0.2...2.5 mm ²
flexible with ferrule with/without plastic sleeve	0.25...2.5 mm ²
Multiple conductor, flexible with TWIN ferrule with plastic sleeve	0.5...1.5 mm ²

Plug-in terminal (l1...l2), (k1...k12), (...MB), (...BMS)

Conductor sizes	AWG 24...16
Stripping length	10 mm
rigid/flexible	0.2...1.5 mm ²
flexible with ferrule without plastic sleeve	0.25...1.5 mm ²
flexible with ferrule with plastic sleeve	0.25...0.75 mm ²

For UL applications

Use copper lines only.

Minimum temperature range of the cable to be connected to the plug-in terminals	75 °C
---	-------

Minimum temperature range of the cable to be connected to the PoE plug	80 °C
--	-------

Environment/EMC

EMC	IEC 61326-1
-----	-------------

Operating temperature

CP907	-10...+55 °C
-------	--------------

CP907 for UL applications	-10...+50 °C
---------------------------	--------------

CP915	-5...+40 °C
-------	-------------

CP924	-5...+40 °C
-------	-------------

Operating altitude	≤ 2000 m AMSL
--------------------	---------------

Rel. humidity	≤ 98 % at 25 °C
---------------	-----------------

Classification of climatic conditions acc. to IEC 60721

Stationary use (IEC 60721-3-3)	3K22
--------------------------------	------

Transport (IEC 60721-3-2)	2K11
---------------------------	------

Long-term storage (IEC 60721-3-1)	1K22
-----------------------------------	------

Classification of mechanical conditions acc. to IEC 60721

Stationary use (IEC 60721-3-3)

CP907	3M11
-------	------

CP915, CP924	3M10
--------------	------

Transport (IEC 60721-3-2)	2M4
---------------------------	-----

Long-term storage (IEC 60721-3-1)	1M12
-----------------------------------	------

Other

Operating mode	Continuous operation
----------------	----------------------

Mounting	Display-oriented
----------	------------------

Degree of protection, front

CP907	IP54
-------	------

CP915, CP924	IP54
--------------	------

Degree of protection, front, for UL applications

CP907	IP50
CP915, CP924	IP54
Degree of protection, enclosure	IP20
Flammability class	UL 94V-0
Dimensions	
CP907 (W x H x D)	226 x 144 x 78 mm
CP915(W x H x D)	505 x 350 x 95 mm
CP924 (W x H x D)	654 x 441 x 100 mm
CP924 portrait (W x H x D)	441 x 654 x 100 mm
Weight	
CP907	< 1.1 kg
CP915	< 7.1 kg
CP924	< 10.5 kg

()* = factory setting

6.3 Standards, approvals and certifications



6.4 Ordering information CP9xx

Complete devices

Type	Display size	Supply	Device dimensions (W x H x D), mm	Weight	Display (glass tempered)	Art. No.
CP907	7" (17.6 cm)	DC 24 V, < 15 W alternatively PoE possible	226 x 144 x 78	1.1 kg	white	B95061080
CP907 without flush-mounting enclosure				0.9 kg	white	B95061093
CP915	15,6" (38.6 cm)	AC 100...240 V < 30 W	505 x 350 x 92	6.1 kg	white	B95061081
					grey	B95061085
CP924	24" (61 cm)	AC 100...240 V, < 55 W	654 x 441 x 100	9.1 kg	white	B95061083
					grey	B95061084

Type	Display size	Supply	Device dimensions (W x H x D), mm	Weight	Display (glass tempered)	Art. No.
CP924 (portait mode)	24" (61 cm)	AC 100...240 V, < 55 W	441 x 654 x 100	9.1 kg	white	B95061086
					grey	B95061087

Scope of delivery:

- Display unit
- Flush-mounting enclosure incl. mounting plate with electronics
- CP9xx connecting cable
- Plug kit

Individual components

Device series	Type	Art. No.
CP907	Flush-mounting enclosure	B95100140
CP915	Display unit, white	B95061112
	Display unit, grey	B95061113
CP924	Display unit, white	B95061115
	Display unit, grey	B95061116

Accessories

Device series	Type	Art. No.
CP907	Surface-mounting enclosure	B95061915
CP915, CP924	CP9xx suction lifter ¹⁾	B95061911
All	CP9xx replacement plug kit	B95061910

1) The suction lifter is required to remove the display

6.5 Document revision history

Date	Document version	Valid from software version	State/Changes
02.2022	08	V4.5.x	<i>Editorial revision</i> Chapter 4.: Indications connection Ethernet and PoE, connections main board Chapter 6.: Reference to D00418 Chapter 8. Cable recommendations and lengths <i>Added</i> Chapters 4.1 and 8.3: Surface-mounting enclosure CP907 UKCA logo

Date	Document version	Valid from software version	State/Changes
03.2023	09	V4.6.x	<i>Editorial revision</i> Chapter "Data modules" Wiring diagram <i>Added</i> Chapter "Device operation, Maintenance, Cleaning", page 29
07.2024	10	V4.9.x	<i>Added</i> UL approval for CP915/CP924 Installation instructions for CP915/924 <i>Removed</i> I ² C interface
03.2025	11		<i>Editorial revision</i> References to other documents as links Mounting instructions (2 suction lifters) Figure Digital inputs Technical data <i>Added</i> Attachment frame Note for safe operation acc.to IEC 60364-7-710 and IEC 61557-8 Ordering information CP924 portrait mode



Bender GmbH & Co. KG

Londorfer Straße 65
35305 Grünberg
Germany

Tel.: +49 6401 807-0
info@bender.de
www.bender.de

Alle Rechte vorbehalten.
Nachdruck und Vervielfältigung nur mit
Genehmigung des Herausgebers.

All rights reserved.
Reprinting and duplicating only with
permission of the publisher.



© Bender GmbH & Co. KG, Germany
Subject to change! The specified
standards take into account the edition
valid until 03.2025 unless otherwise
indicated.